

ENTRE//MATIC

AXK4 Series



IP2292 - 018/06/08

Avvertenze generali per la sicurezza

- Conservate le presenti istruzioni per futuri riferimenti.
- L'installazione, i collegamenti elettrici e le regolazioni devono essere effettuati da personale tecnico qualificato nell'osservanza della Buona Tecnica e in ottemperanza alle norme vigenti.
- Questo prodotto dovrà essere destinato solo all'uso per il quale è stato espressamente concepito. Ogni altro uso è da considerarsi improprio e quindi pericoloso. Il costruttore non può essere considerato responsabile per eventuali danni causati da usi impropri, erronei ed irragionevoli.
- Leggere attentamente le istruzioni prima di iniziare l'installazione del prodotto. Una errata installazione può essere fonte di pericolo.
- Prima di iniziare l'installazione verificare l'integrità del prodotto.
- Non installare il prodotto in ambiente e atmosfera esplosivi: presenza di gas o fumi infiammabili costituiscono un grave pericolo per la sicurezza.
- Pericolo di esplosione se la batteria viene sostituita con una di tipo non corretto.
-  I materiali dell'imballaggio (plastica, polistirolo, ecc.) non vanno dispersi nell'ambiente e non devono essere lasciati alla portata dei bambini in quanto potenziali fonti di pericolo.

Smaltimento rifiuti elettrici/elettronici



Il simbolo del cassonetto barrato indica che il prodotto non può essere eliminato con i comuni rifiuti domestici. Il prodotto deve essere riciclato nel rispetto delle norme ambientali locali per lo smaltimento dei rifiuti. Separando un prodotto contrassegnato da questo simbolo dai rifiuti domestici, si aiuterà a ridurre il volume dei rifiuti destinati agli inceneritori o alle discariche, minimizzando così qualsiasi possibile impatto negativo sulla salute umana e sull'ambiente.

Per lo smaltimento della batteria, attenersi alle norme vigenti nella propria area di residenza. La batteria non può essere smaltita nei rifiuti domestici!

General safety precautions

- *Keep these instructions for future reference.*
- *Installation, electrical connections and adjustments must be performed by qualified personnel in accordance with Good Working Methods and in compliance with the current standards.*
- *This product must only be used for the specific purpose for which it was designed. Any other use is to be considered improper and therefore dangerous. The manufacturer cannot be held responsible for any damage caused by improper, incorrect or unreasonable use.*
- *Read the instructions carefully before installing the product. Incorrect installation may cause danger.*
- *Before installing the product, make sure it is in perfect condition.*
- *Do not install the product in explosive areas and atmospheres: the presence of inflammable gas or fumes represents a serious safety hazard.*
- *Danger of explosion if a battery is replaced with an incorrect type.*
-  *The packaging materials (plastic, polystyrene, etc.) should not be discarded in the environment or left within reach of children, as they are a potential source of danger.*

Disposal of electric /electronic waste



The crossed-out wheeled bin symbol indicates that the product should be disposed of separately from household waste. The product should be handed in for recycling in accordance with local environmental regulations for waste disposal. By separating a marked item from household waste, you will help reduce the volume of waste sent to incinerators or landfill and minimize any potential negative impact on human health and the environment.

Observe all applicable legal requirements for your area when disposing of the battery. The battery may not be disposed of in the domestic refuse bin!



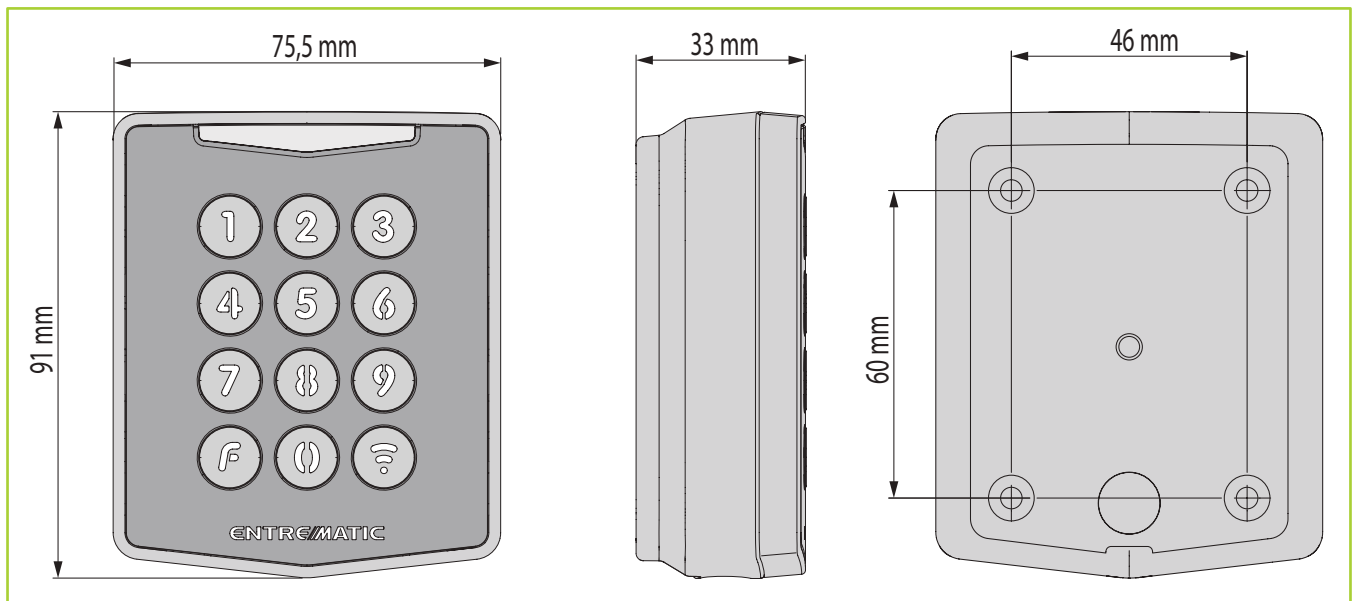

1. Dimensioni

1. Dimensions



2. Dati tecnici

2. Technical specifications

	AXK4	AXK4P/PS
Frequenze operative <i>Operating frequency</i>	433,92 MHz	868,35 MHz
Potenza irradiata <i>Radiated Power</i>	< 1 mW	< 1 mW
Protocollo di trasmissione <i>Transmission protocol</i>	Rolling code data frame (può essere cambiato con AES-128) <i>(can be changed to AES.128)</i>	AES-128 encrypted data frame (può essere cambiato con Rolling code) <i>(can be changed to Rolling code)</i>
Canali disponibili <i>Available channels</i>	Quattro (CH1, CH2, CH3, CH4), attivati con quattro differenti codici numerici. <i>Four (CH1, CH2, CH3, CH4), activated with four different numerical codes.</i>	
Distanza <i>Range</i>	50 m - 150 m (esterno, in linea d' aria) / <i>(outdoors, line of sight)</i>	
Alimentazione <i>Power supply</i>	9 volt alkaline battery, 6LR61 	LITHIUM LITHIUM ION
Alimentazione esterna [*]  <i>External power supply [*]</i>	12 - 24 volt DC	
Grado di protezione <i>Protection degree</i>	IP55	
Range temperatura di utilizzo (°C) <i>Operating temperature range (°C)</i>	 -20°C -  +50°C	
Peso <i>Weight</i>	165 g	

Attention! Le batterie esaurite devono essere deposte nei contenitori RAEE dedicati o nei centri di raccolta adeguati.
Attention! Exhausted batteries must be disposed into dedicated WEEE containers or collection center.

[*] Avvertenza! Assicurarsi di disconnettere la batteria interna quando viene utilizzata l' alimentazione esterna.
L' alimentazione esterna va usata solo **in alternativa** a quella interna.

[*] Warning! Make sure the internal battery is disconnected when the external power supply is being used.
The external power supply should only be used **as an alternative** to the internal one.



3. Dichiarazione di conformità UE

3. EU declaration of conformity

Il fabbricante Entrematic Group AB con sede in Lodjursgatan 10, SE-261 44 Landskrona, Svezia, dichiara che i prodotti AXK4, AXK4P e AXK4PS sono conformi ai requisiti essenziali e ad altre disposizioni pertinenti della Direttiva 2014/53/UE RED.

The manufacturer Entrematic Group AB with headquarters in Lodjursgatan 10, SE-261 44 Landskrona, Sweden, declares that the products AXK4, AXK4P and AXK4PS comply with the essential requirements and other relevant provisions of Directive 2014/53/EU (RED).

Landskrona, 2018-05-02



Matteo Fino
(President Entrematic Itay S.p.A.)

4. Destinazione d'uso

4. Intended use

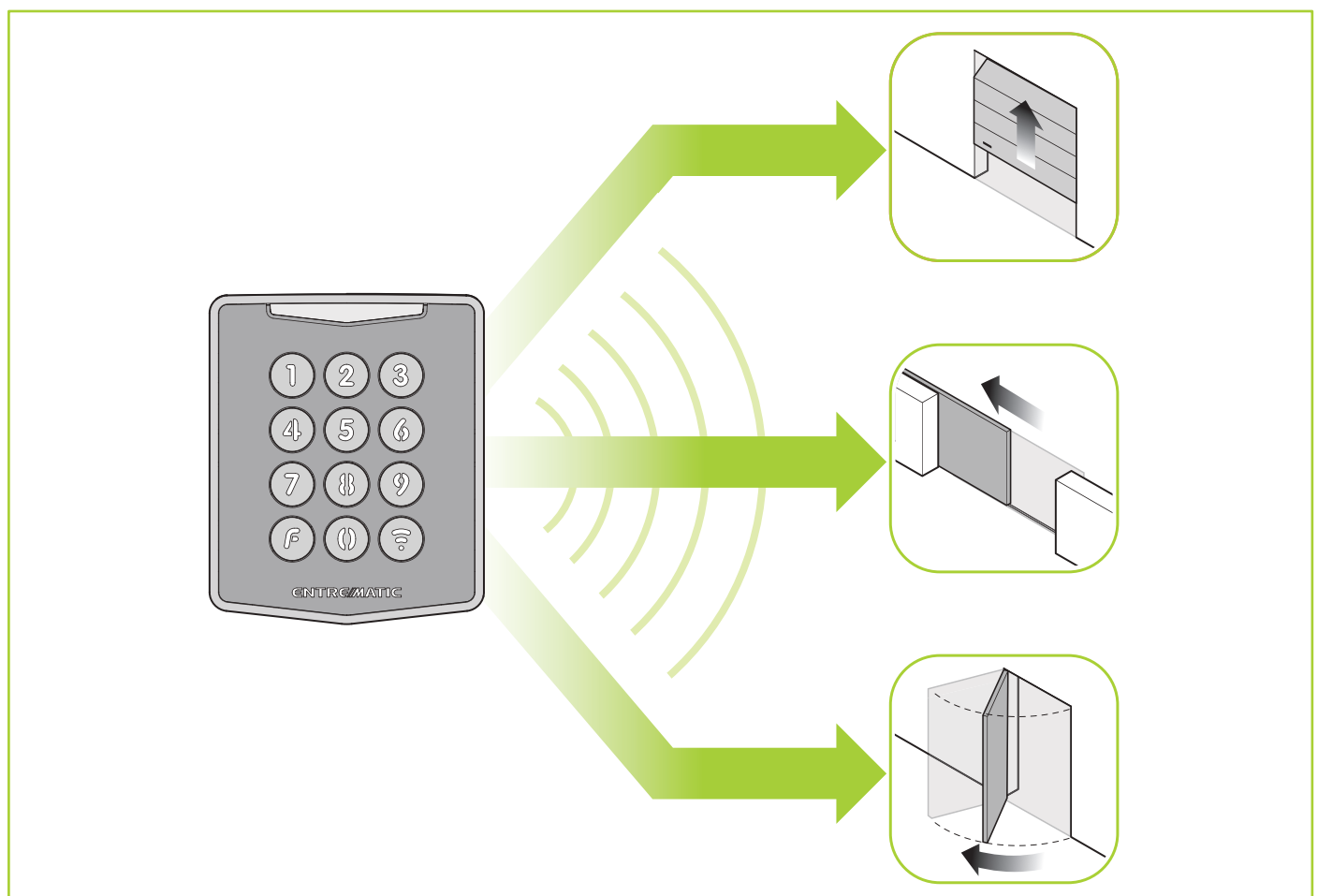

5. Fasi installazione

5. Installation

STEP 1

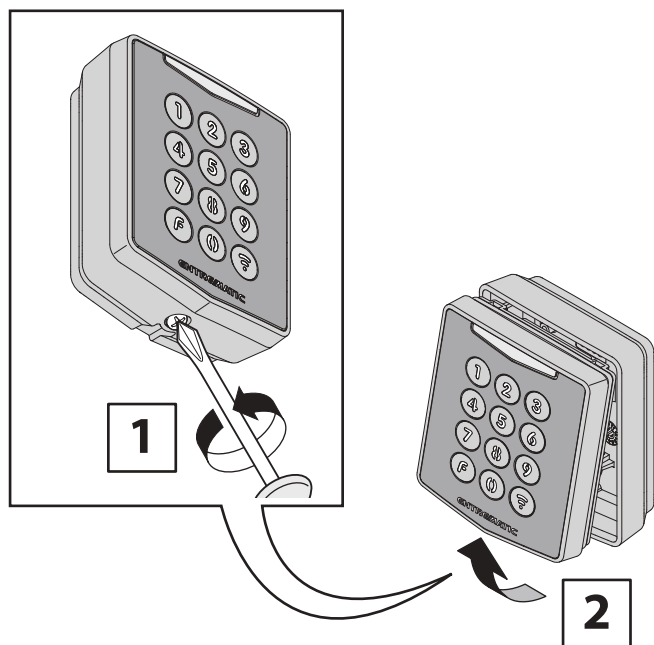

STEP 2

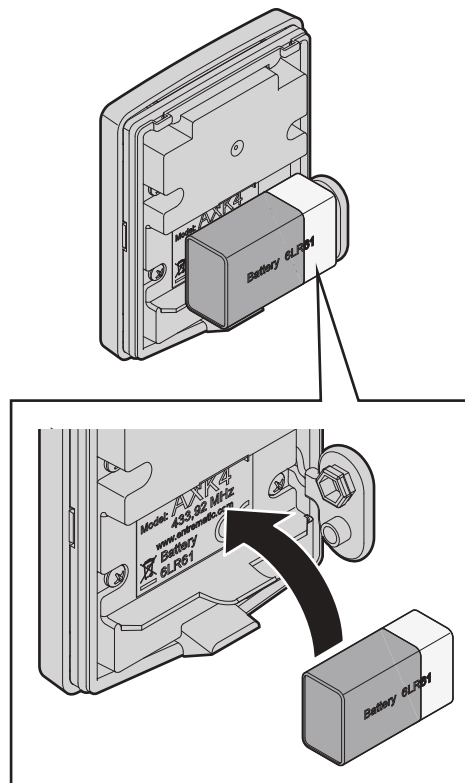

STEP 3

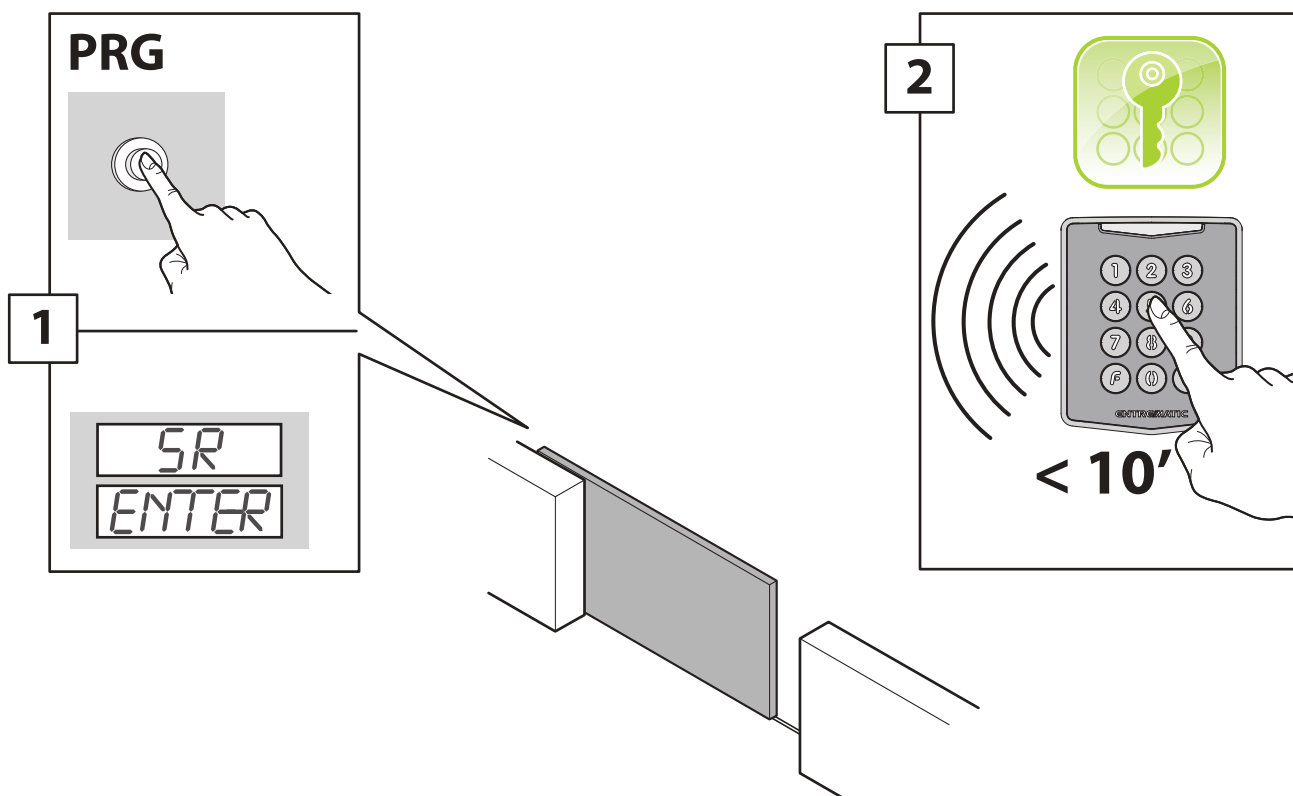

STEP 4

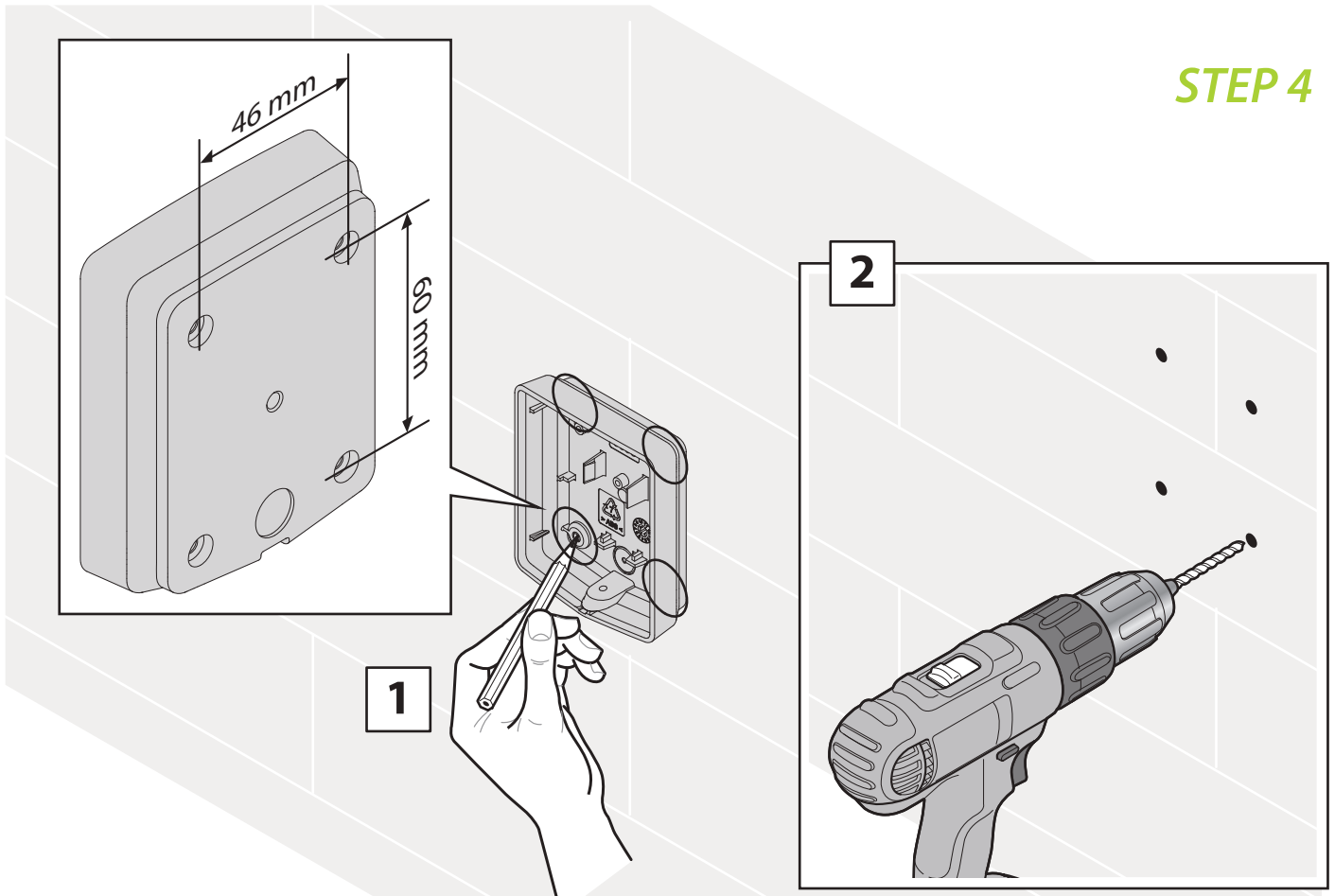

STEP 5

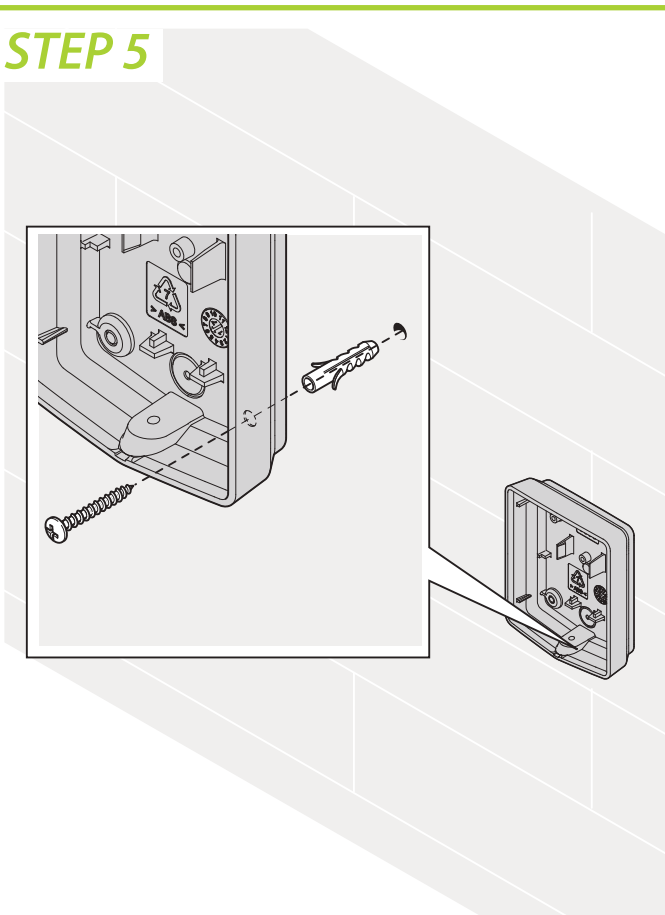

STEP 5A

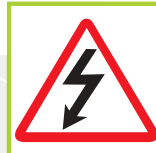

Solo per alimentazione esterna.
For external power supply only.

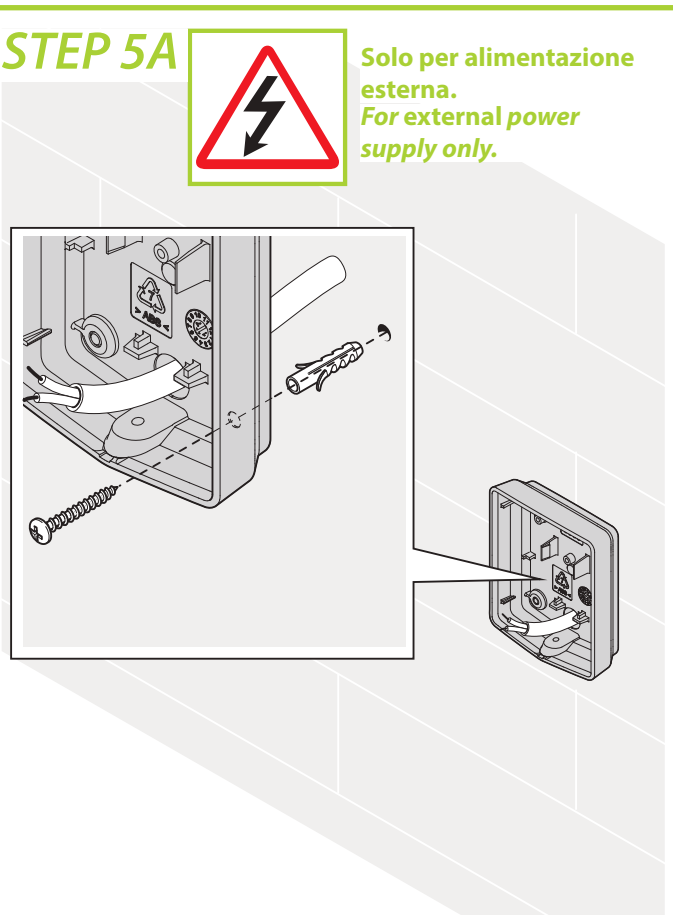

STEP 6



Solo per alimentazione esterna.
For external power supply only.

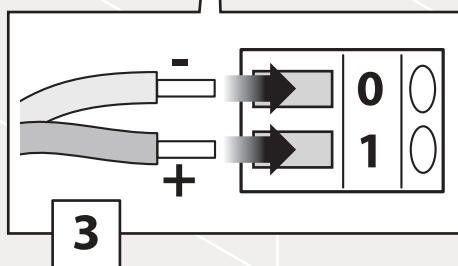
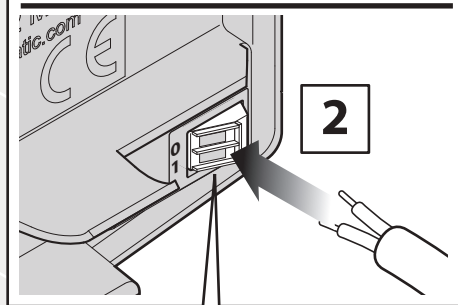
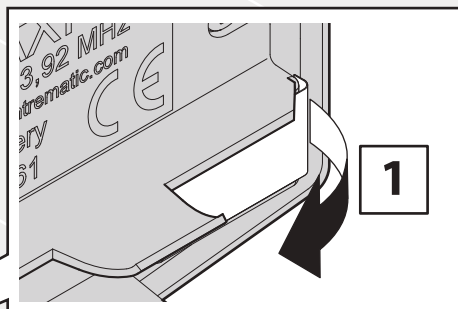
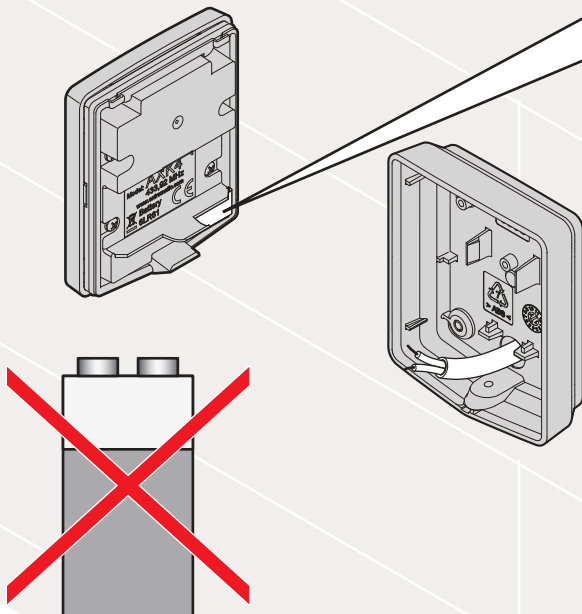

STEP 7

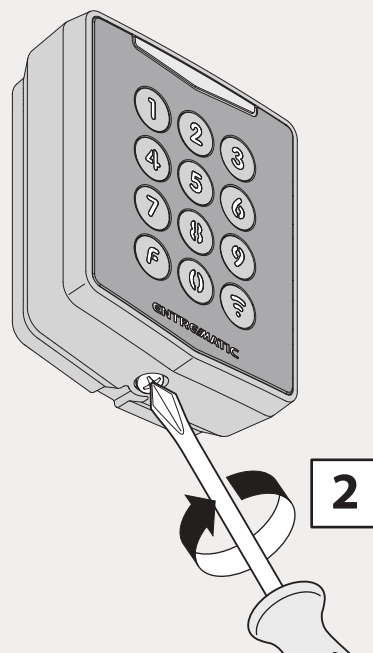
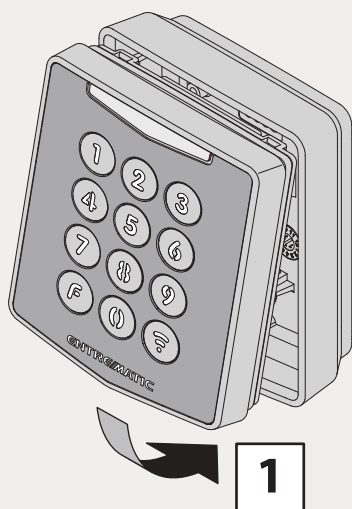

6. Sostituzione batteria

6. Replacing the battery

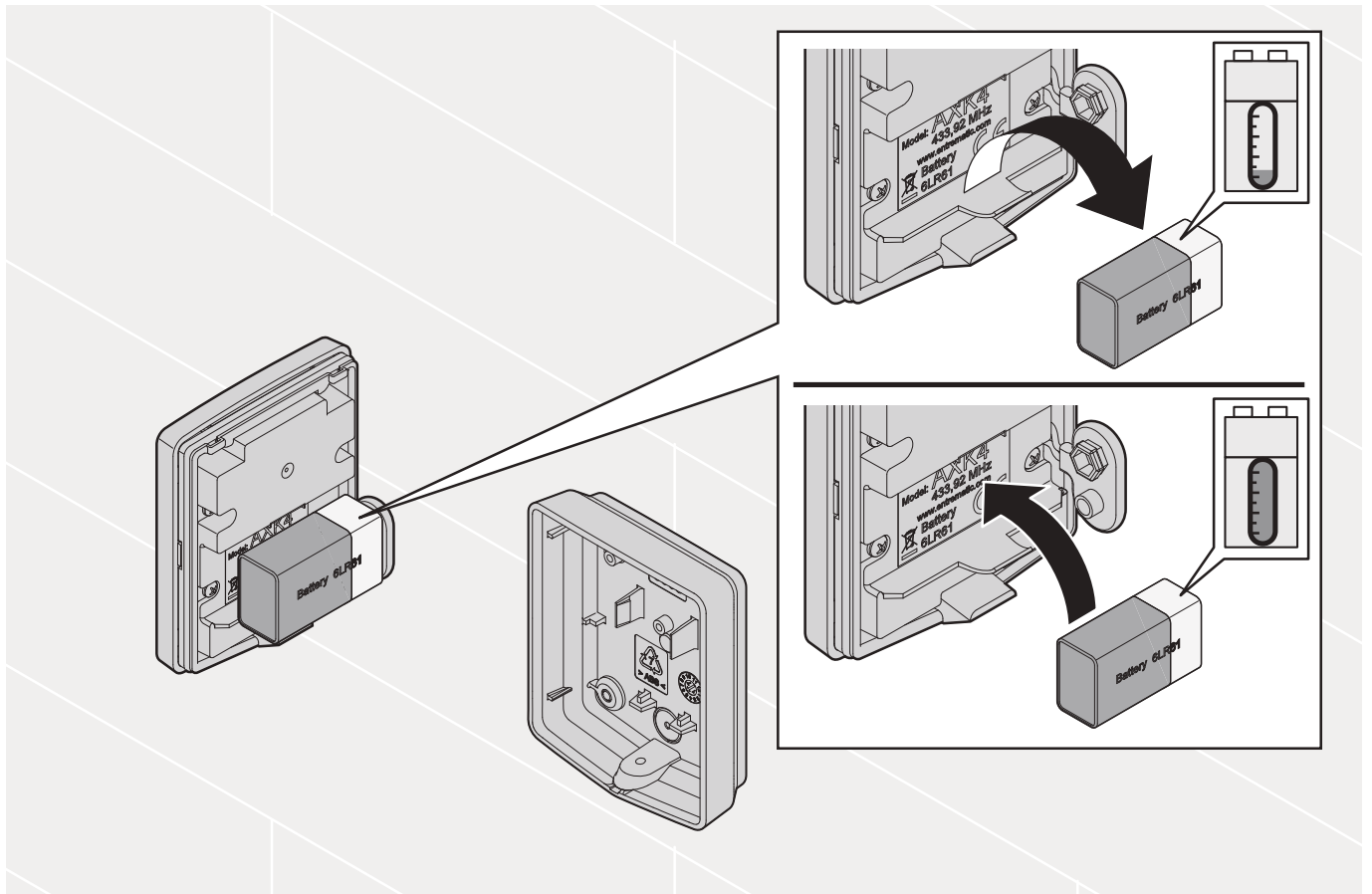

7. Descrizione icone 7. Description of the icons



Impostazioni di fabbrica
Factory settings



Codice di configurazione
Configuration code



Sblocco apparecchiatura
Device release



Blocco apparecchiatura
Device locking



Lasso di tempo
Time lapse



Codice
Code



Luce verde fissa
Fixed green light



Luce verde intermittente
Flashing green light



Luce rossa fissa
Fixed red light



Luce rossa intermittente
Flashing red light

CH

Canale (1, 2, 3, 4)
Channel (1, 2, 3, 4)



Tasto qualunque, eccetto
Any key, except



Solo personale qualificato
Qualified personnel only



Codice errato
Wrong code

8. Codici di fabbrica

8. Factory default numerical codes

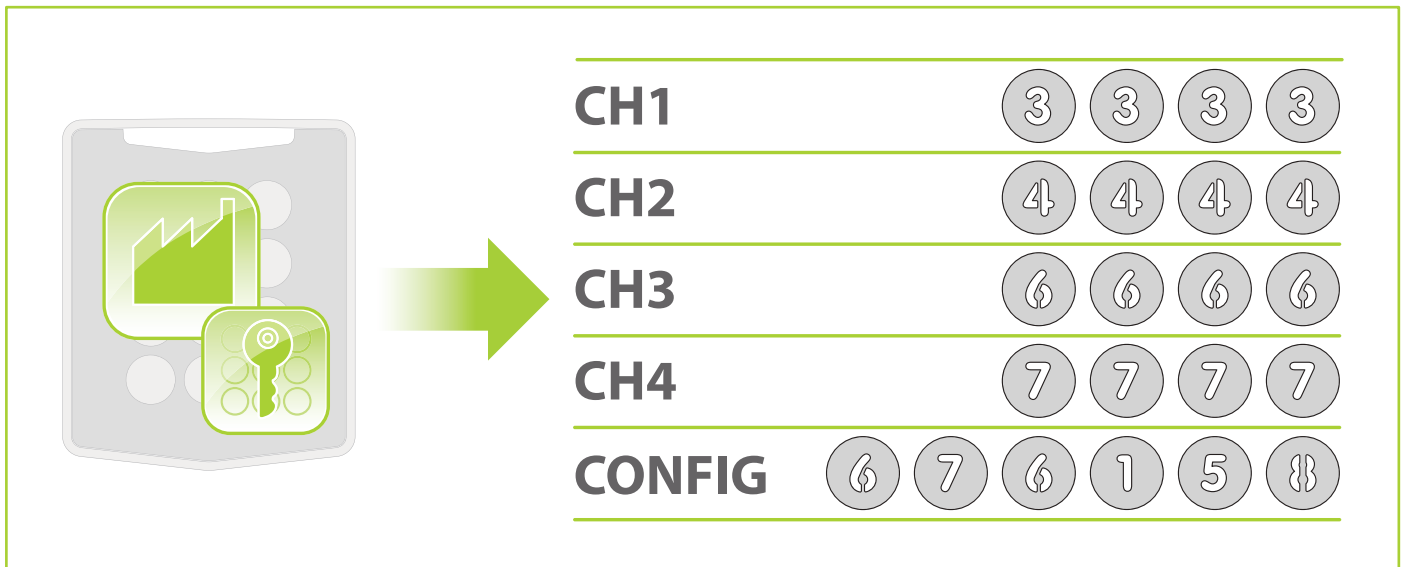

9. Sequenze di comando di base

9. Basic user command sequences

- Attivare CHn
- Activate CHn

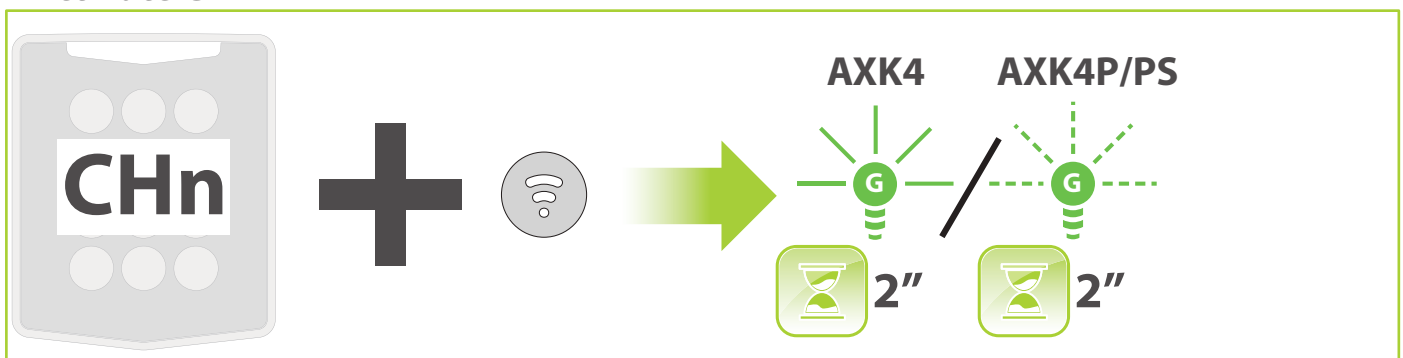

- Attivare Canale LIBERO (se configurato)
- Activate FREE Channel (if set)



- Ripetere ultimo comando (entro 10 s)
- *Repeat last command (within 10 s)*

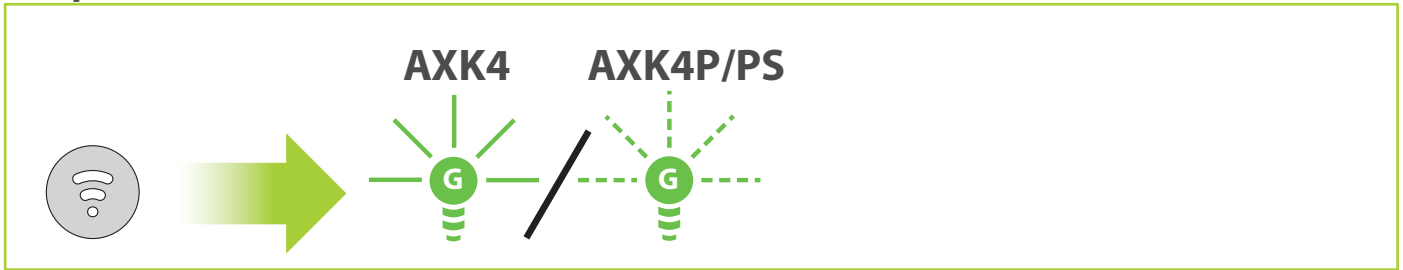

- Attivare retroilluminazione
- *Activate Backlight*

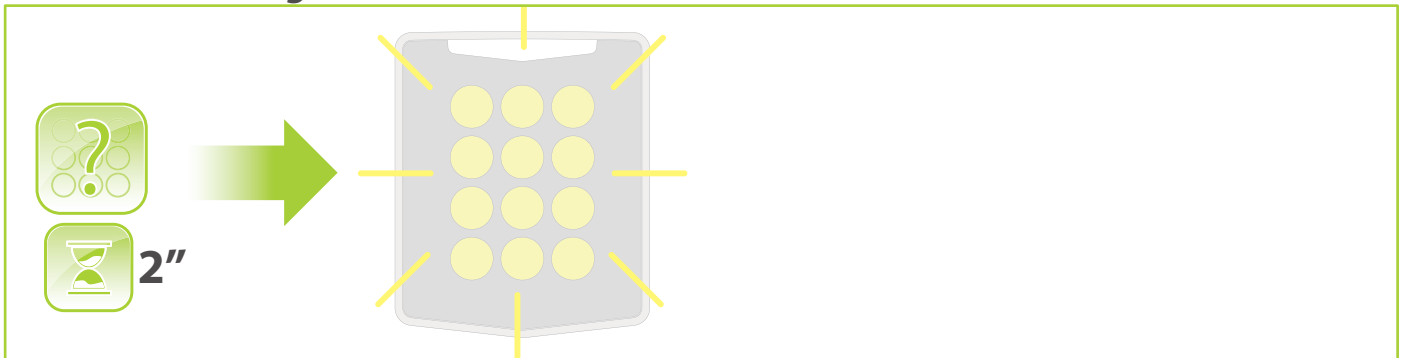

- Cancellare sequenza appena digitata
- *Cancel currently typed key sequence*
- Uscire da modalità "Ripetere ultimo comando"
- *Exit "repeat last command" mode*



- Identificazione modello
- *Model identification*

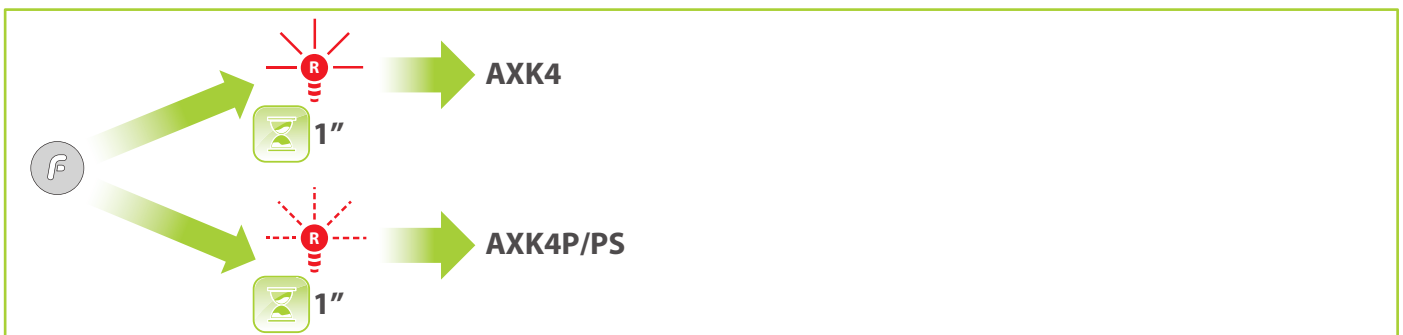

- Errata digitazione di un codice
- *Incorrect code entered*

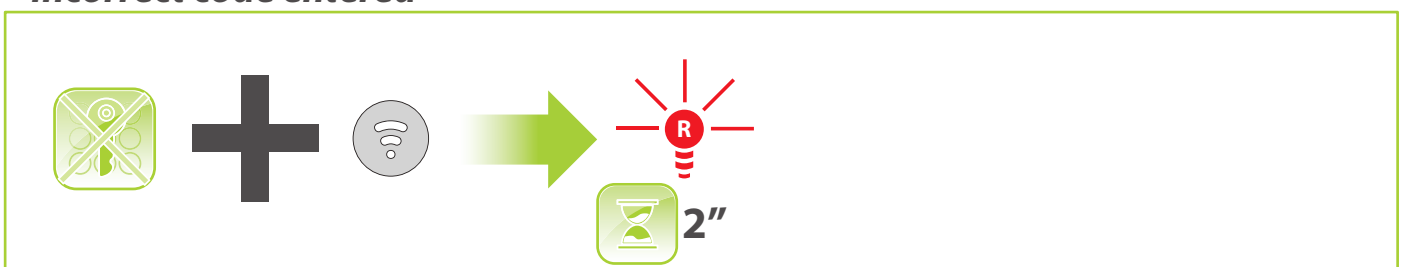

- Inserimento ripetuto di codice errato
- *Incorrect code entered more than once*



- Qualsiasi sequenza di tasti incompleta viene ignorata dopo 10 s di inattività, ritornando alla condizione di stand-by.
- La pausa fra la pressione di un tasto e di quello successivo deve essere inferiore a 5 s.
- *Any incomplete key sequence is aborted after 10 seconds of inactivity, returning to stand-by condition.*
- *Pause between sequence key pressings must be shorter than 5 seconds.*

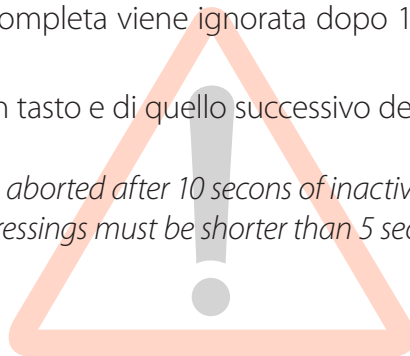

10. Sequenza per cambio codici

10. Code change sequences

- Cambiare vecchio codice con uno nuovo
- *Replacing the old code with a new one*

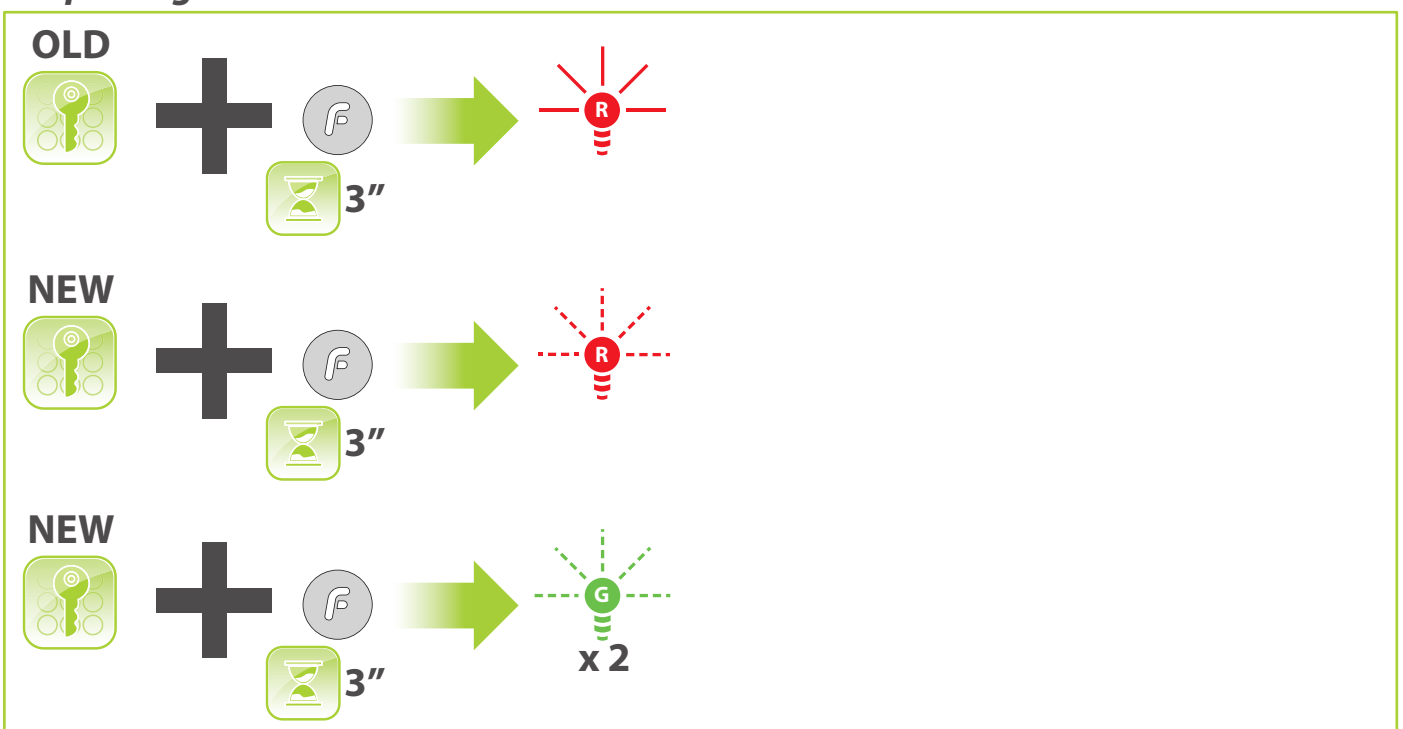

- Configurazione di un codice a "lunghezza zero" (Canale LIBERO)
- Setting a "zero length" code (free channel)

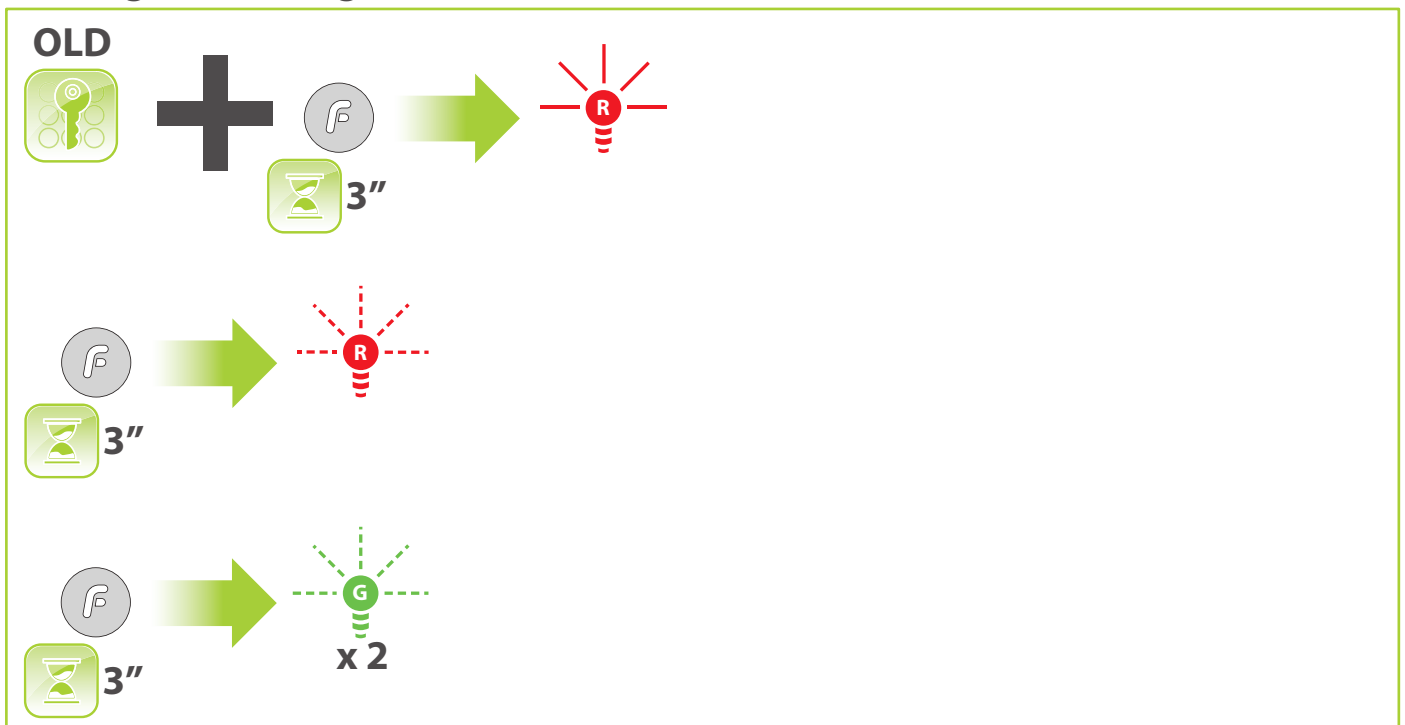

- I codici utente devono avere una lunghezza fra 0 (canale LIBERO) e 8 cifre.
- Soltanto un singolo canale può essere configurato come "Canale LIBERO".
- Di conseguenza, i codici di fabbrica non possono essere usati per attivare canali diversi da quelli predefiniti (per esempio, il codice "3333" non può essere usato su CH4).
- Una sequenza di cambio codice incompleta viene ignorata dopo 10 s di inattività, ritornando alla condizione di stand-by.
- Una sequenza di cambio codice errata causa l'accensione del LED ROSSO per 3 s, dopodiché il prodotto ritorna alla condizione di stand-by.

- *User code must have a length between 0 digits (free channel) and 8 digits*
- *Only one single channel can be configured as "free channel".*
- *Consequently, factory default codes cannot be used for other channels than the factory predefined ones (for instance, code 3333 cannot be used for CH4).*
- *An incomplete code change sequence is aborted after 10 seconds of inactivity, returning to stand-by condition.*
- *A wrong code change sequence causes the RED LED to turn ON for 3 seconds and the product returns to stand-by condition.*

11. Stato CONFIG

11. CONFIG state



- Cambiare vecchio codice CONFIG con uno nuovo
- *Replacing the old CONFIG code with a new one*

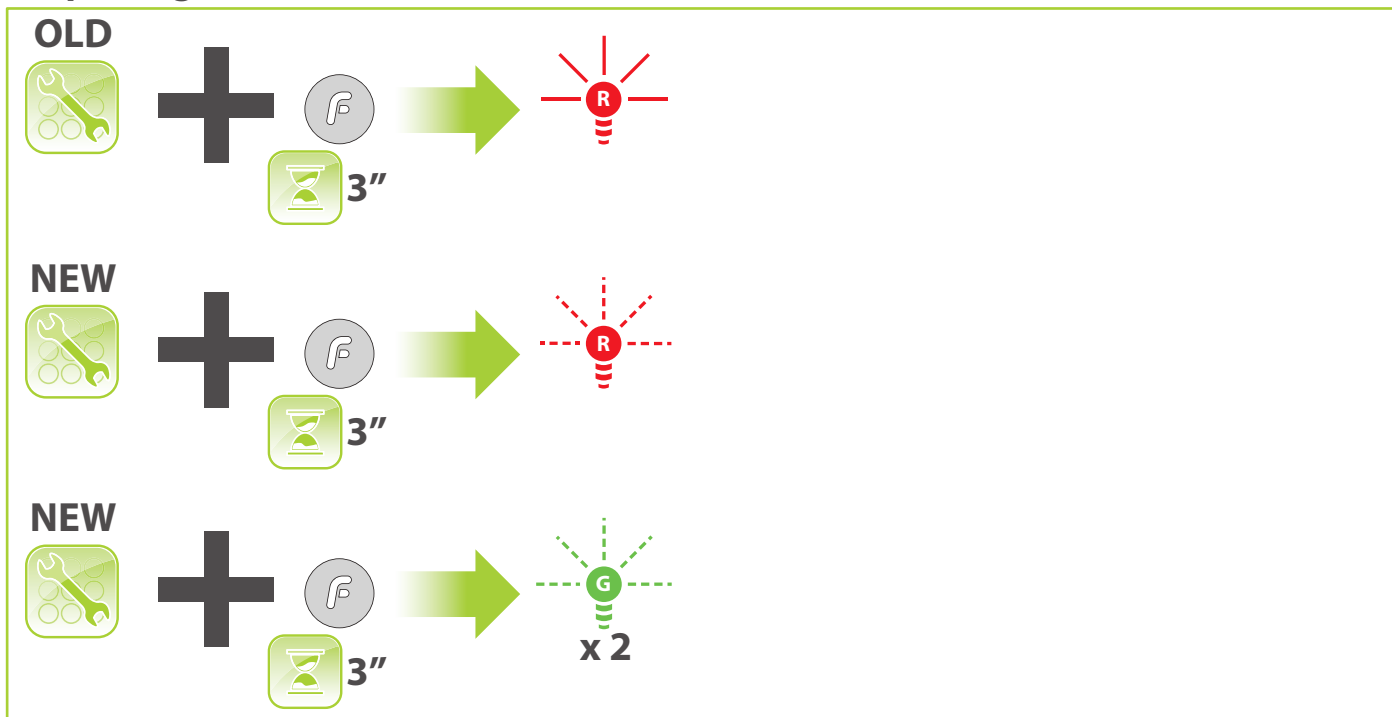

- Accesso alla modalità CONFIG
- *Access CONFIG state*

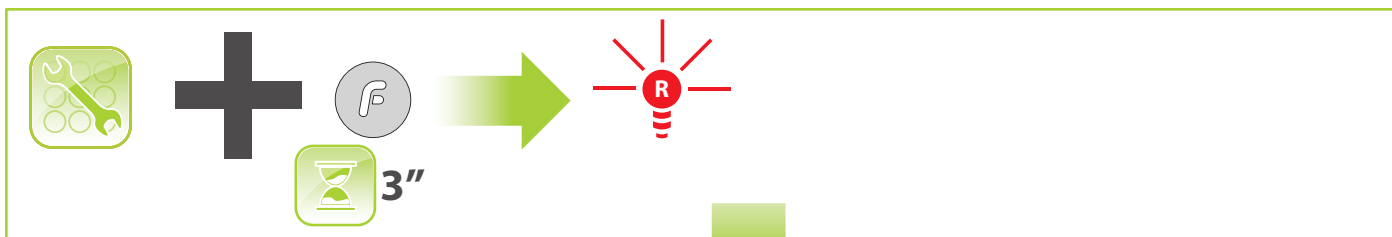

- Ripristinare Canale LIBERO a default
- *Restore FREE channel to default*

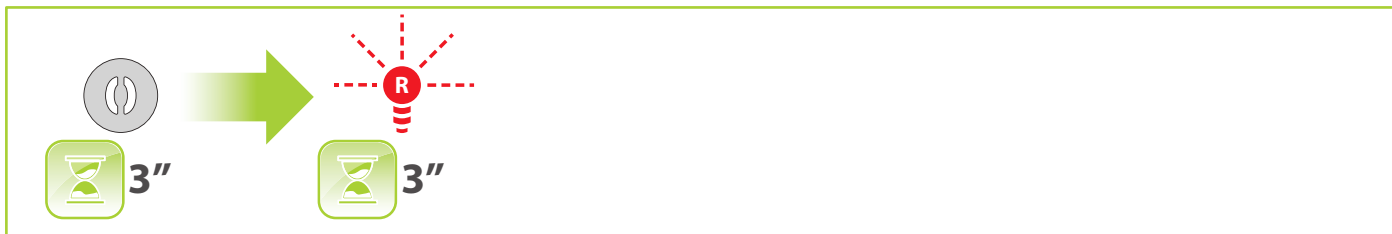

- Commutare ROLL / ENC su CH1-CH2
- *Toggle ROLL / ENC su CH1-CH2*

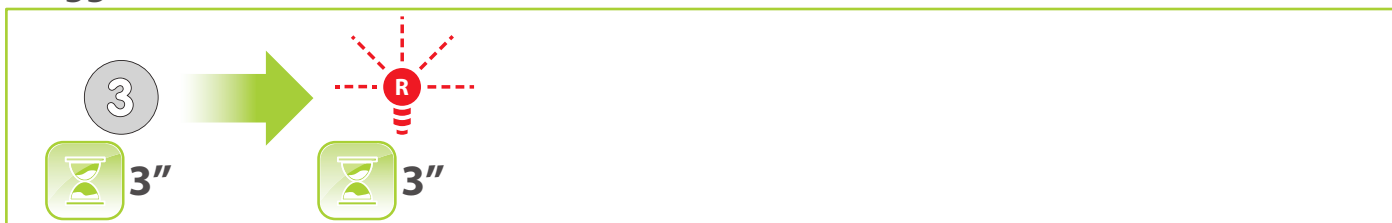



- Commutare ROLL / ENC su CH3-CH4
- *Toggle ROLL / ENC su CH3-CH4*

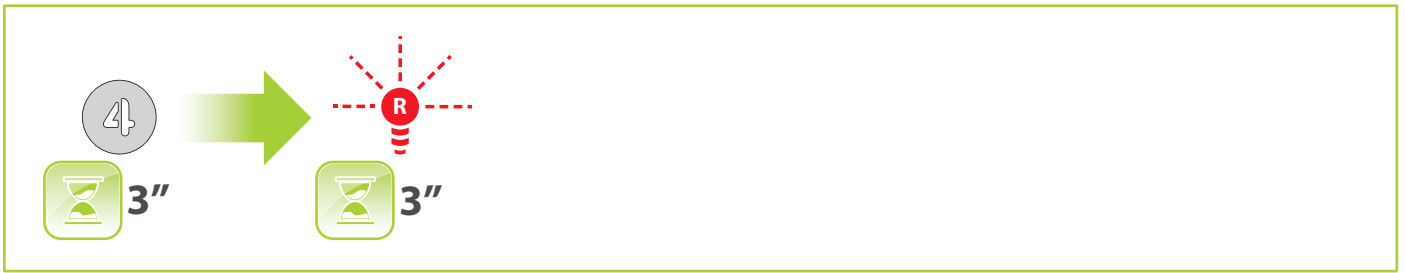

- ABILITARE funzione cambio codici
- *Code Change function ENABLE*

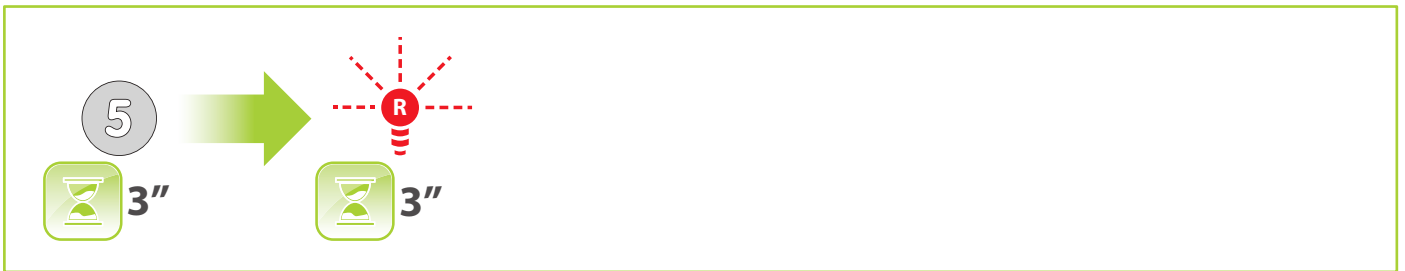

- DISABILITARE funzione cambio codici
- *Code Change function DISABLE*

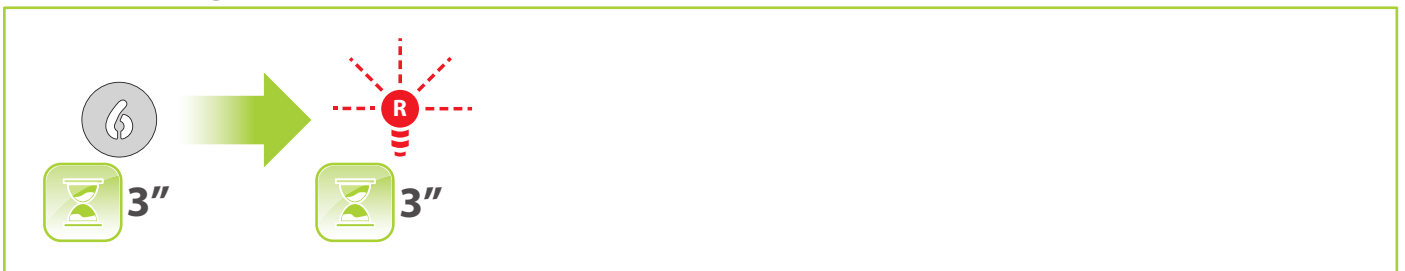

- RIPRISTINO configurazione di fabbrica
- *RESET to Factory Default condition*

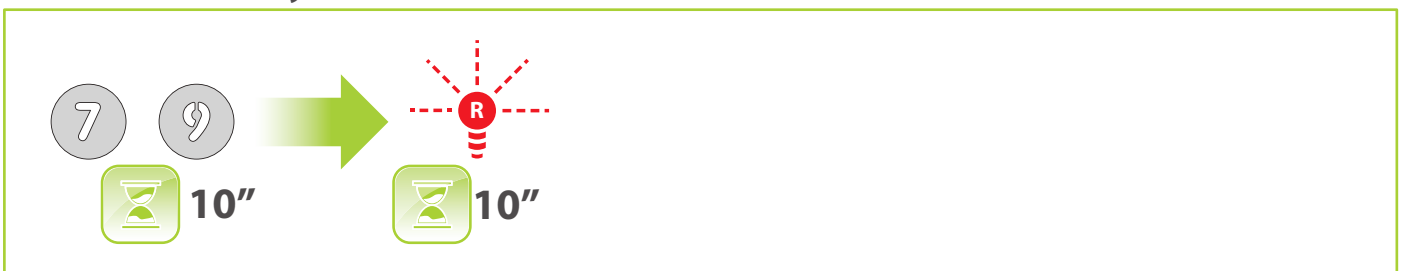

- BLOCCO totale configurazione
- *Total configuration LOCK*





- Il codice di configurazione (CONFIG) deve avere una lunghezza fra 4 e 8 cifre.
 - Una volta che si accede allo stato di configurazione, il tempo disponibile per effettuare l'operazione desiderata è pari a 30 s. Se si supera questo tempo senza concludere l'operazione in corso, il prodotto ritorna alla condizione di stand-by senza effettuare alcun cambiamento sul prodotto.
 - Una volta attivato il BLOCCO totale configurazione, non è più possibile effettuare alcuna modifica alla configurazione o il RESET di fabbrica.
-
- *CONFIG Access code must have a length between 4 an 8 digits.*
 - *Once access to configuration status is done, the time to execute a configuration action is of 30 seconds; when time is elapsed, the keypad return to stand-by condition without changes in the product.*
 - *Once Total Configuration LOCK is activated, configuration changes and factory RESET are not possible anymore.*



Entromatic Group AB
Lodjursgatan 10
SE-261 44, Landskrona
Sweden
www.entromatic.com



ENTRE//MATIC

AXK4 Series



IP2292 - 018/06/08

Allgemeine Sicherheitshinweise

- Bewahren Sie diese Anweisungen für zukünftiges Nachschlagen auf.
- Die Montage, die elektrischen Anschlüsse und Einstellungen müssen von qualifiziertem Fachpersonal unter Beachtung der Guten Technik und Einhaltung der geltenden Normen auszuführen.
- Dieses Produkt darf ausschließlich für die bestimmungsgemäße Verwendung eingesetzt werden. Jeder andere Gebrauch ist als unsachgemäß und daher gefährlich zu betrachten. Der Hersteller lehnt jede Haftung für Schäden infolge eines unsachgemäßen, falschen und unvernünftigen Gebrauchs ab.
- Lesen Sie die Anleitungen vor der Montage des Produktes aufmerksam durch. Eine fehlerhafte Montage kann zu Verletzungen und Sachschäden führen.
- Vor Beginn der Montage ist der einwandfreie Zustand des Produkts zu überprüfen.
- In explosionsgefährdeten Bereichen darf das Produkt nicht eingebaut werden: Entzündbare Gase oder Rauch stellen eine ernsthafte Sicherheitsgefährdung dar.
- Explosionsrisiko, wenn die Batterie durch einen falschen Typ ersetzt wird.
-  Die Verpackungsmaterialien (Kunststoff, Polystyrol usw.) müssen sachgemäß entsorgt werden und dürfen nicht in Kinderhände gelangen, da sie eine Gefahrenquelle darstellen können.

Entsorgung von Elektro-/Elektronikmüll



Das durchgestrichene Mülltonnensymbol zeigt an, dass das Produkt nicht über den normalen Hausmüll entsorgt werden darf. Das Produkt muss in Übereinstimmung mit den örtlichen Umweltvorschriften für die Abfallentsorgung recycelt werden. Die Trennung eines mit diesem Symbol gekennzeichneten Produkts vom Hausmüll trägt dazu bei, das Abfallaufkommen in Verbrennungsanlagen oder Deponien zu verringern und so mögliche negative Auswirkungen auf die menschliche Gesundheit und die Umwelt zu minimieren.

Entsorgen Sie die Batterie entsprechend den lokalen Bestimmungen. Entsorgen Sie die Batterie nicht mit dem Haushaltsmüll!

Consignes générales de sécurité

- Conserver les présentes instructions pour de futures consultations.
- L'installation, les raccordements électriques et les réglages doivent être effectués par un technicien qualifié selon les règles de la bonne technique et conformément aux normes en vigueur.
- Ce produit n'est destiné qu'à l'utilisation pour laquelle il a été conçu. Toute autre utilisation doit être considérée comme impropre et donc dangereuse. Le fabricant ne peut pas être considéré responsable d'éventuels dommages causés par un usage impropre, irrationnel ou erroné.
- Lire les instructions avec beaucoup d'attention avant d'installer le produit. Une mauvaise installation peut être source de danger.
- Avant de commencer l'installation, contrôler l'intégrité du produit.
- Ne jamais installer le produit dans un milieu de travail ou une atmosphère explosive: la présence de gaz ou de fumées inflammables représente un grave danger pour la sécurité.
- Danger d'explosion si la batterie est remplacée par un autre type incorrect.
-  Les matériaux qui composent l'emballage (plastique, polystyrène, etc.) ne doivent pas être abandonnés dans la nature ni laissés à la portée des enfants car ils représentent des risques de danger.

Élimination des déchets d'équipements électriques et électroniques



Le symbole de la poubelle barrée indique que le produit ne peut pas être éliminé avec les ordures ménagères ordinaires. Il doit être recyclé conformément à la réglementation environnementale locale en matière de déchets. En triant les produits portant ce pictogramme, vous contribuez à réduire le volume des déchets incinérés ou enfouis, et à diminuer tout impact négatif sur la santé humaine et l'environnement.

Lors de l'élimination de la pile, respecter les réglementations en vigueur dans votre zone de résidence. La pile ne peut pas être jetée dans les ordures ménagères!



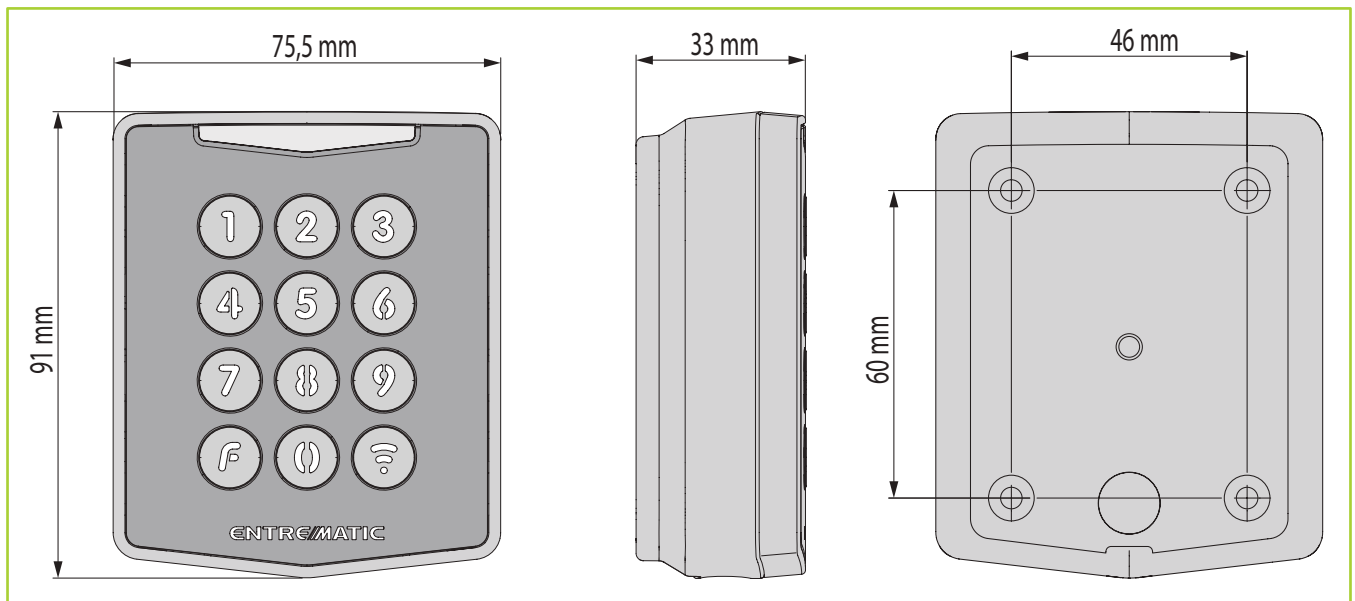

1. Abmessungen

1. Dimensions



2. Technische Angaben

2. Caractéristiques techniques

	AXK4	AXK4P/PS
Betriebsfrequenzen <i>Fréquences de fonctionnement</i>	433,92 MHz	868,35 MHz
Strahlungsleistung <i>Puissance rayonnée</i>	< 1 mW	< 1 mW
Übertragungsprotokoll <i>Protocole de transmission</i>	Rolling code data frame (kann mit AES-128 geändert werden) <i>(peut être modifié par AES-128)</i>	AES-128 encrypted data frame (kann mit Rolling code geändert werden) <i>(peut être modifié par Rolling code)</i>
Verfügbare Kanäle <i>Canaux disponibles</i>	Vier (CH1, CH2, CH3, CH4), aktiviert mit vier verschiedenen numerischen Codes. <i>Quatre (CH1, CH2, CH3, CH4), activés par quatre différents codes numériques.</i>	
Abstand <i>Distance</i>	50 m - 150 m (außen, in Luftlinie) / <i>(extérieur, à vol d'oiseau)</i>	
Stromversorgung <i>Tension</i>	9 volt alkaline battery, 6LR61	 LITHIUM LITHIUM ION
Externe Stromversorgung [*] <i>Alimentation externe [*]</i> 	12 - 24 volt DC	
Schutzgrad <i>Degré de protection</i>	IP55	
Betriebstemperaturbereich (°C) <i>Plage de température d'utilisation (°C)</i>	 -20°C -  +50°C	
Gewicht <i>Poids</i>	165 g	

Achtung! Altbatterien müssen in speziellen WEEE-Containern oder bei geeigneten Sammelstellen entsorgt werden.

Attention ! Les batteries épuisées doivent être déposées dans des conteneurs DEEE spécifiques ou apportées à des centres de collecte appropriés.

[*] Warnhinweis! Achten Sie darauf, die interne Batterie zu trennen, wenn Sie die externe Stromversorgung verwenden. Das externe Netzteil darf nur **als Alternative** zum internen Netzteil verwendet werden.

[*] Avertissement ! Veiller à débrancher la batterie interne lorsque l'alimentation externe est utilisée. L'alimentation externe ne doit être utilisée que comme alternative à l'alimentation interne.



3. EU-Konformitätserklärung

3. Déclaration UE de conformité

Der Hersteller Entrematic Group AB mit Sitz in Lodjursgatan 10, SE-261 44 Landskrona, Schweden, erklärt, dass die Produkte AXK4, AXK4P und AXK4PS den wesentlichen Anforderungen und sonstigen Bestimmungen der RED-Richtlinie 2014/53/EU entsprechen.

Le fabricant Entrematic Group AB sis à Lodjursgatan 10, SE-261 44 Landskrona, Suède, déclare que les produits AXK4, AXK4P et AXK4PS sont conformes aux exigences essentielles et aux autres dispositions pertinentes de la Directive 2014/53/UE RED.

Landskrona, 2018-05-02



Matteo Fino

(President Entrematic Itay S.p.A.)

4. Verwendungszweck

4. Destination d'usage

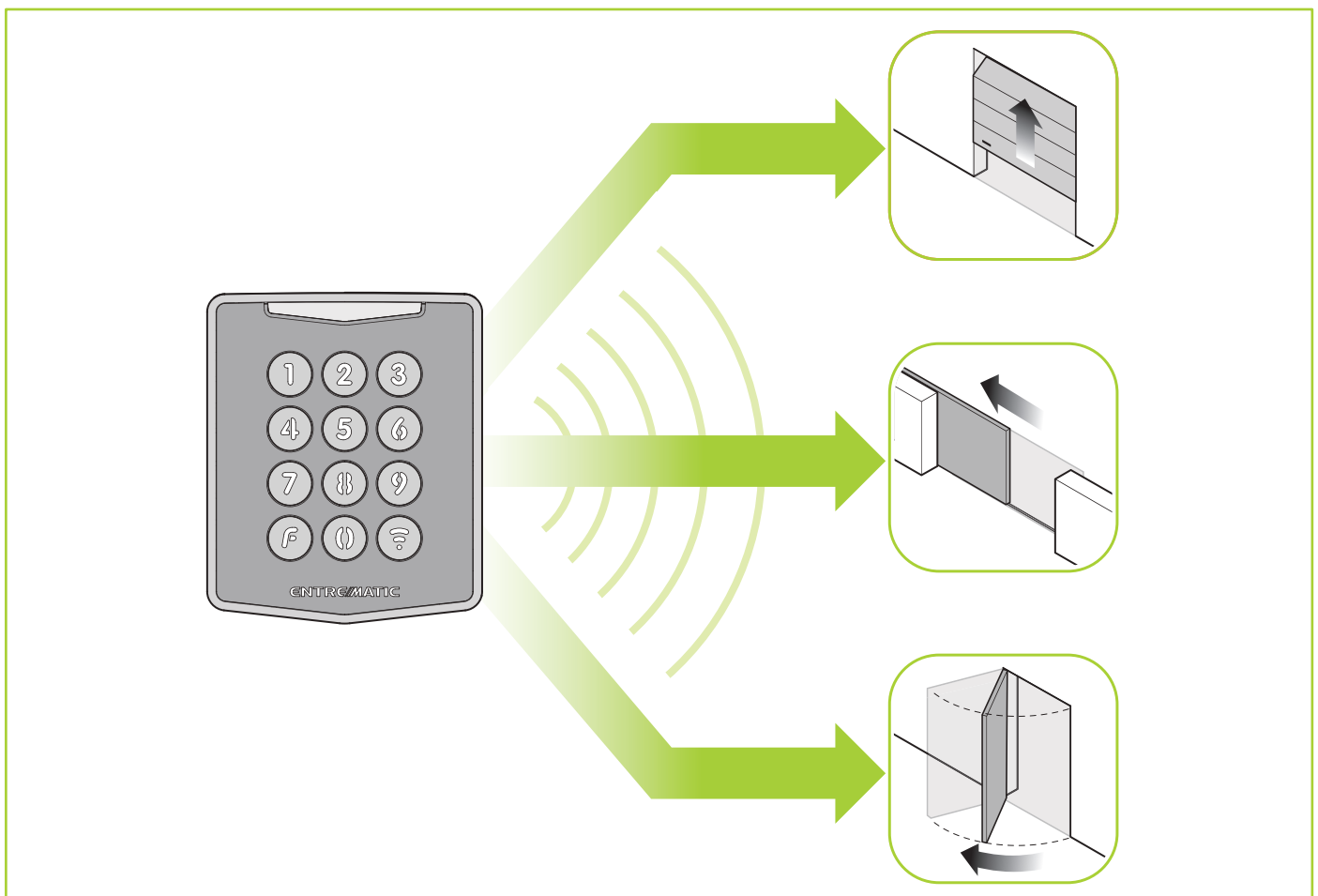

5. Installationsphasen

5. Phases d'installation

STEP 1

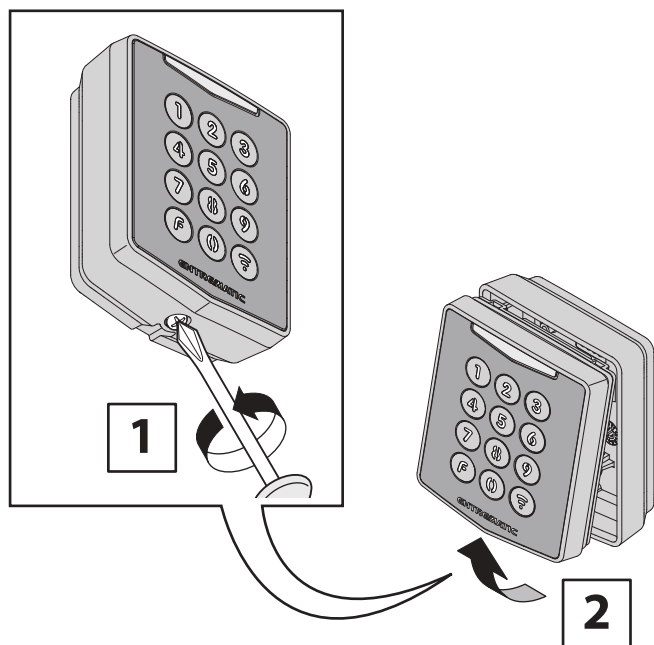

STEP 2

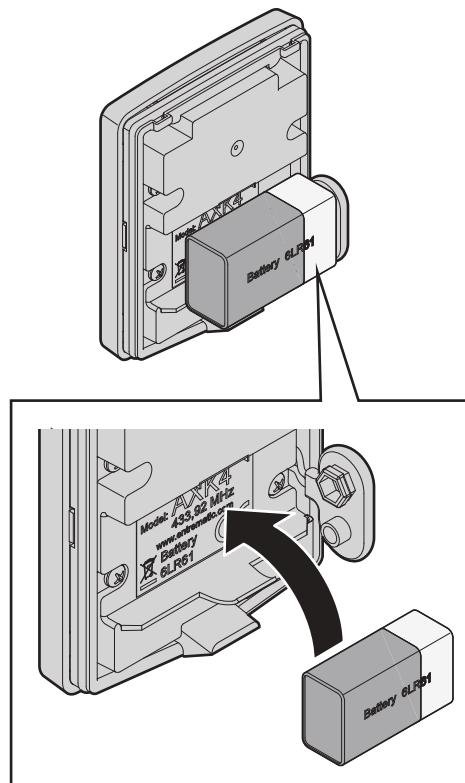

STEP 3

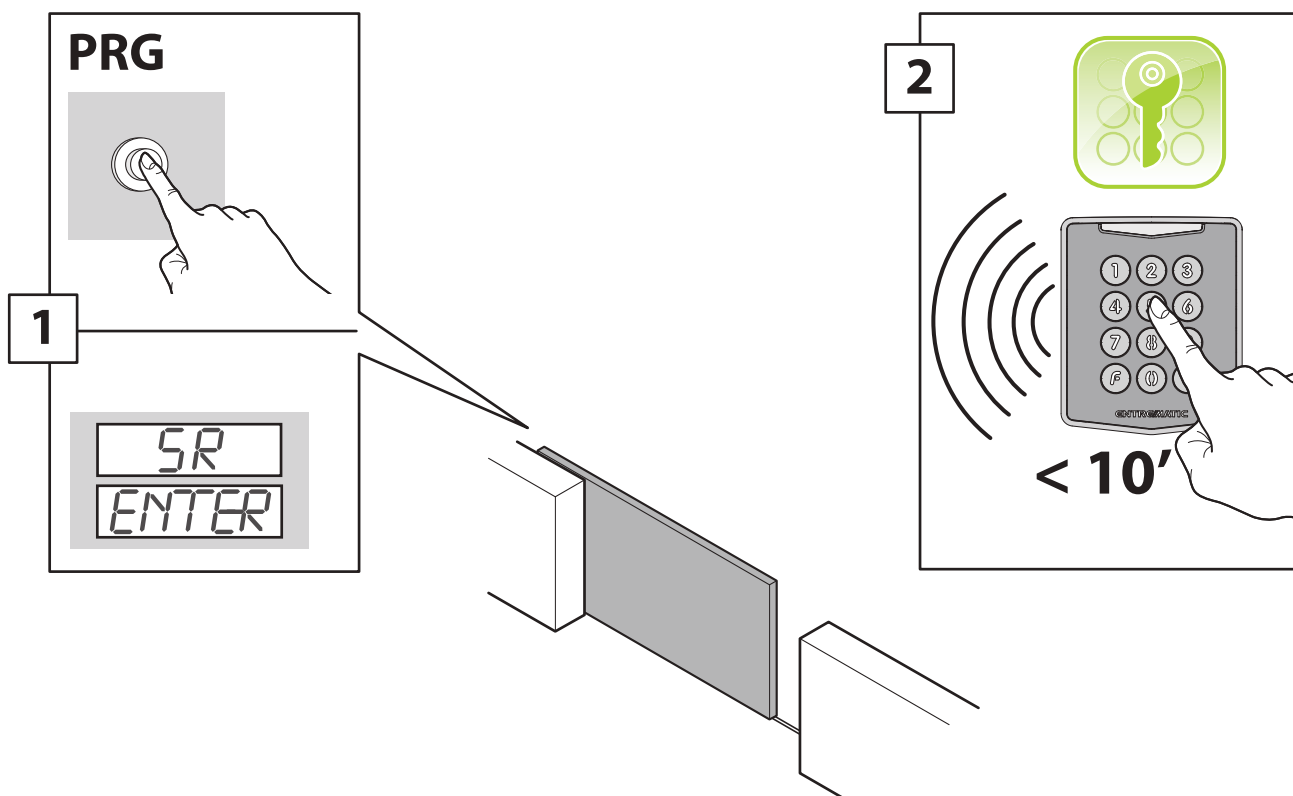

STEP 4

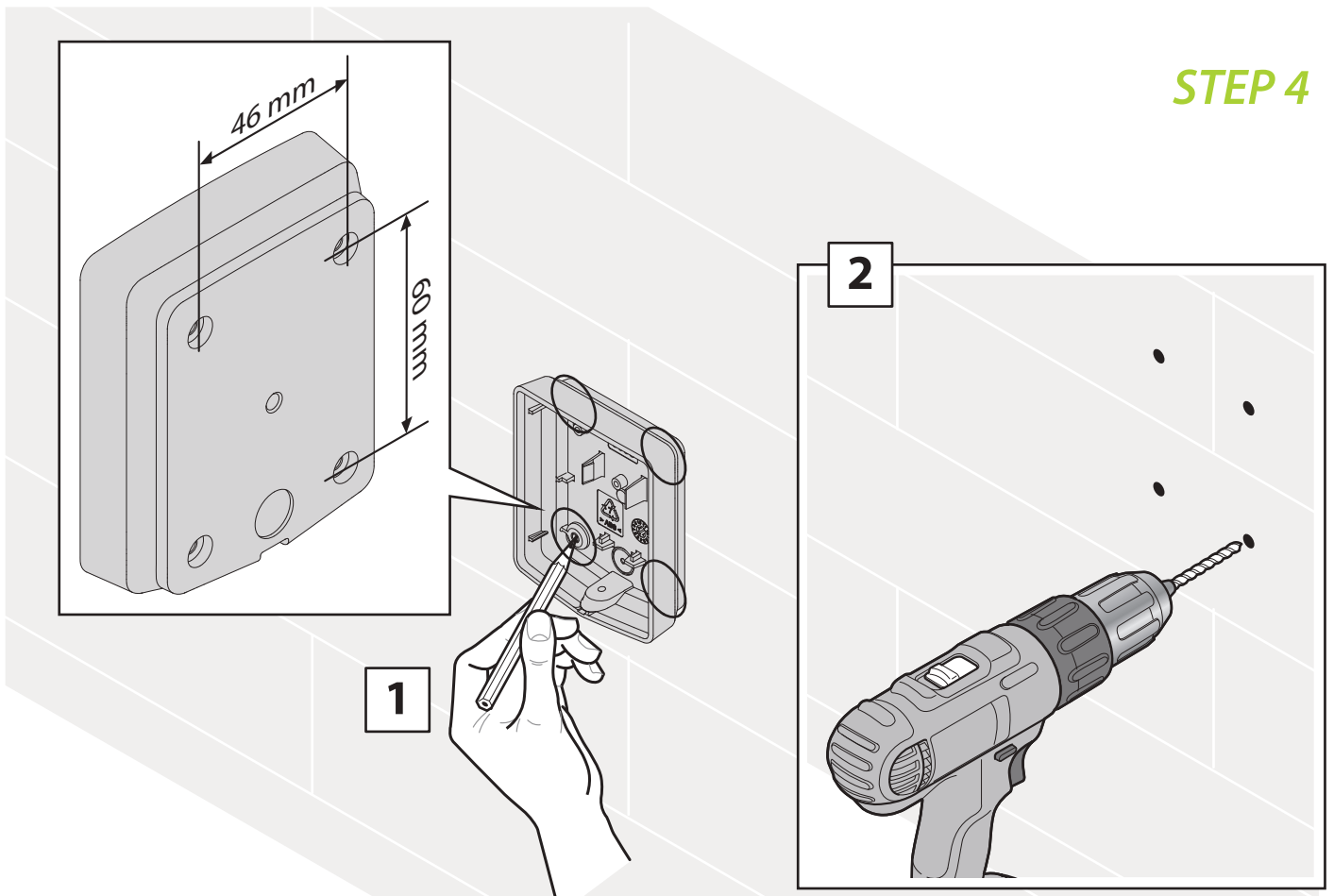

STEP 5

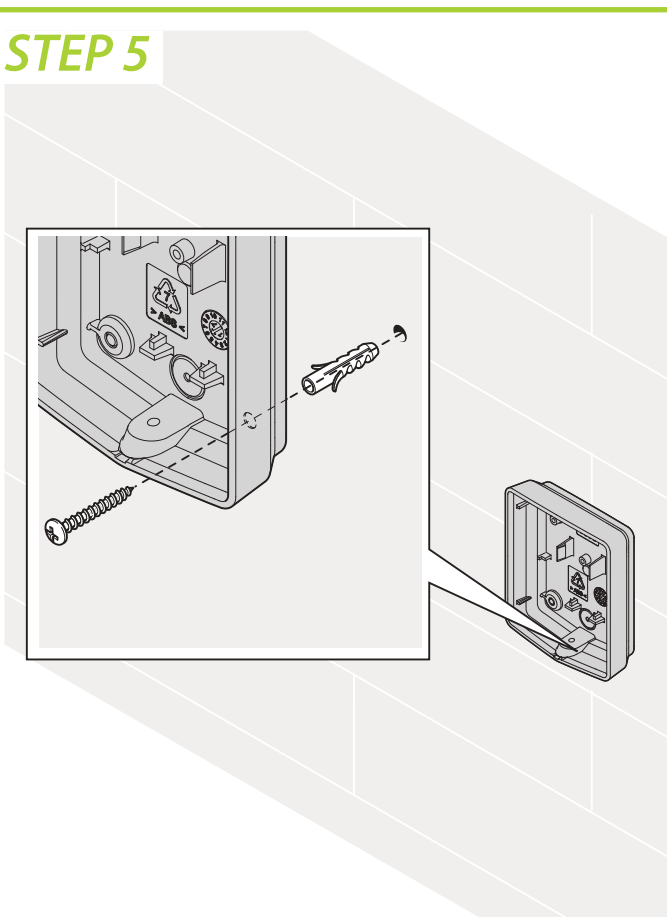

STEP 5A

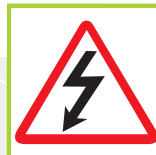

Nur für externe Stromversorgung.
Seulement pour alimentation externe.

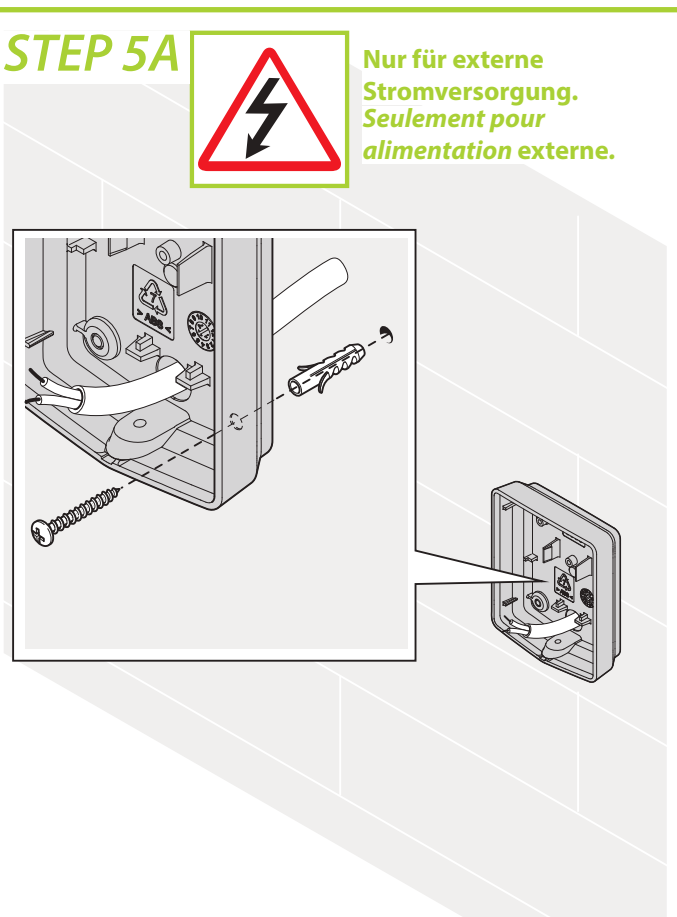

STEP 6



Nur für externe
Stromversorgung.
Seulement pour
alimentation externe.

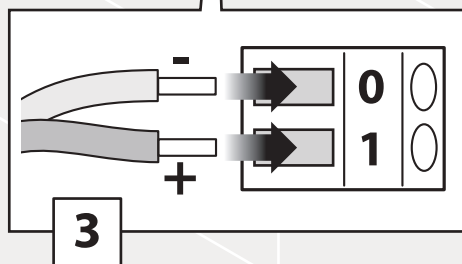
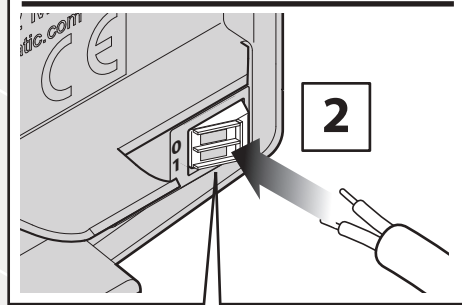
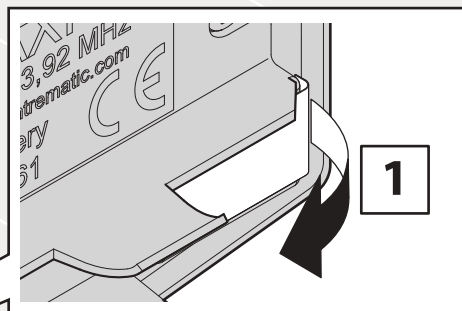
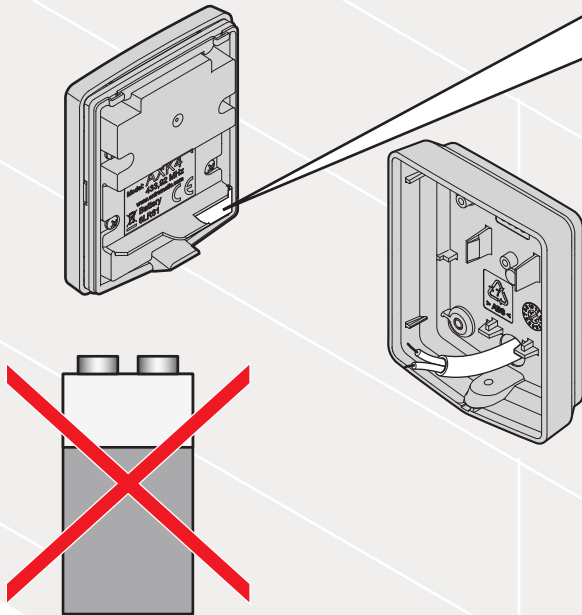

STEP 7

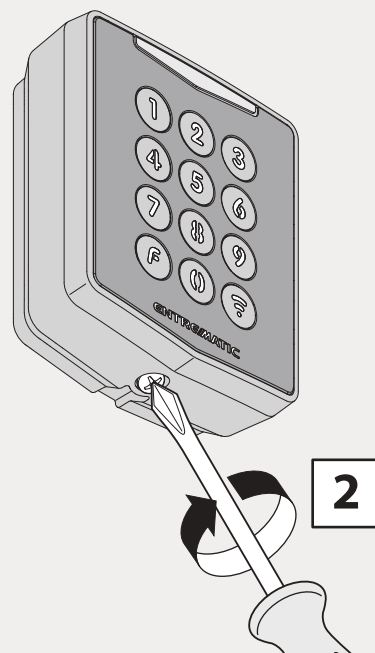
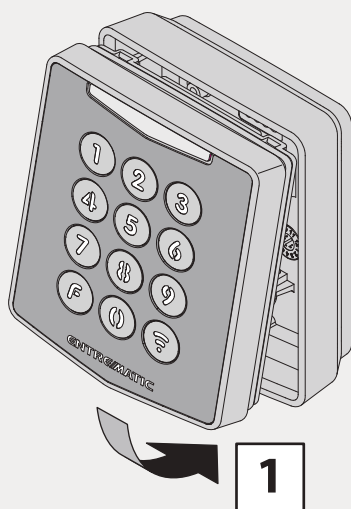

6. Batteriewechsel

6. Remplacement de la batterie

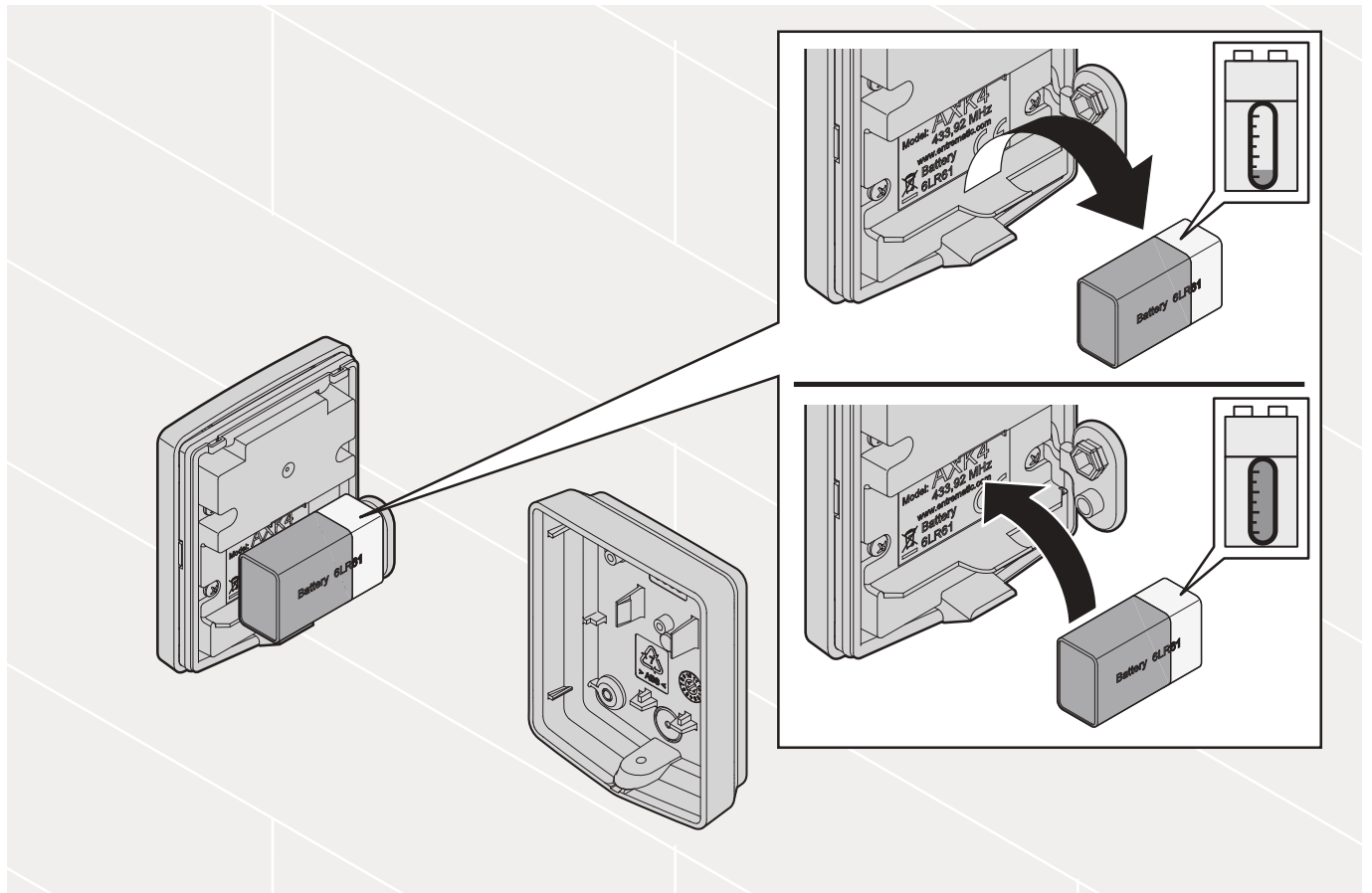

7. Symbolbeschreibung 7. Description des icônes



Werkseinstellungen
Réglages d'usine



Konfigurationscode
Code de configuration



Gerätentriegelung
Déverrouillage de l'appareil



Gerätverriegelung
Verrouillage de l'appareil



Zeitspanne
Laps de temps



Code
Code



Dauerhaftes grünes Licht
Lumière verte fixe



Blinkendes grünes Licht
Lumière verte intermittente



Dauerhaftes rotes Licht
Lumière rouge fixe



Blinkendes rotes Licht
Lumière rouge intermittente

CH

Kanal (1, 2, 3, 4)
Canal (1, 2, 3, 4)



Jede Taste, außer

N'importe quelle touche, sauf



Nur qualifiziertes Personal
Uniquement personnel qualifié



Falscher Code
Code incorrect



8. Fabrikcodes 8. Codes d'usine

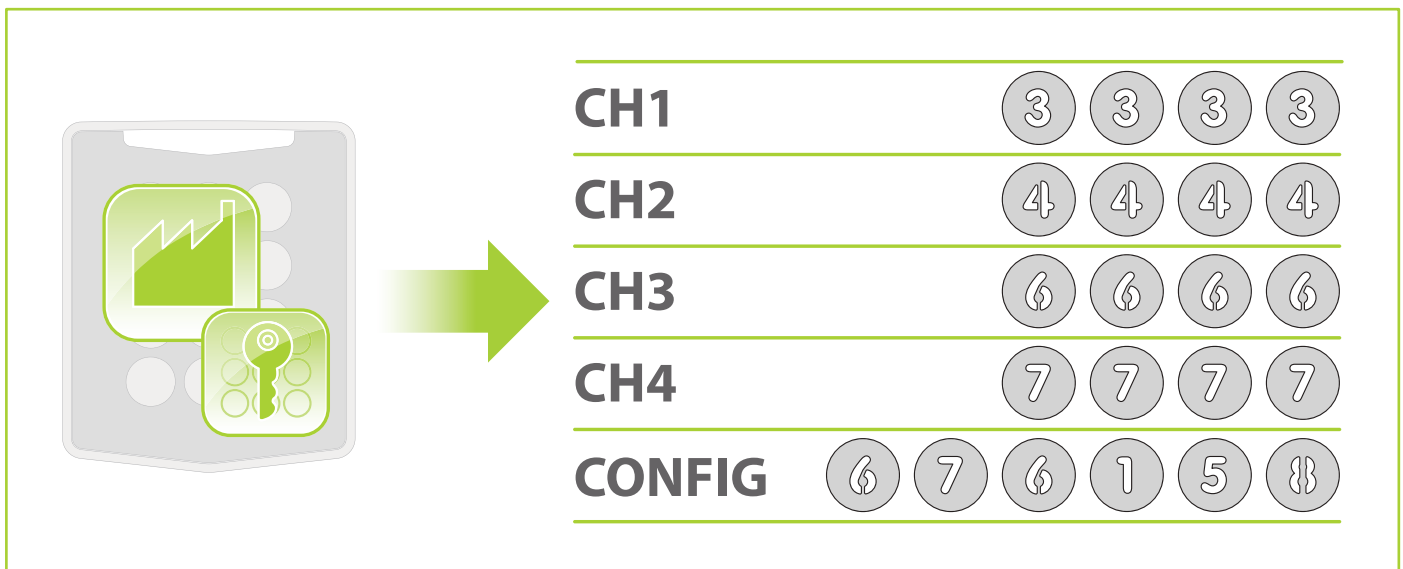

9. Grundlegende Steuersequenzen 9. Séquences de commande de base

- CHn aktivieren
- Activer CHn

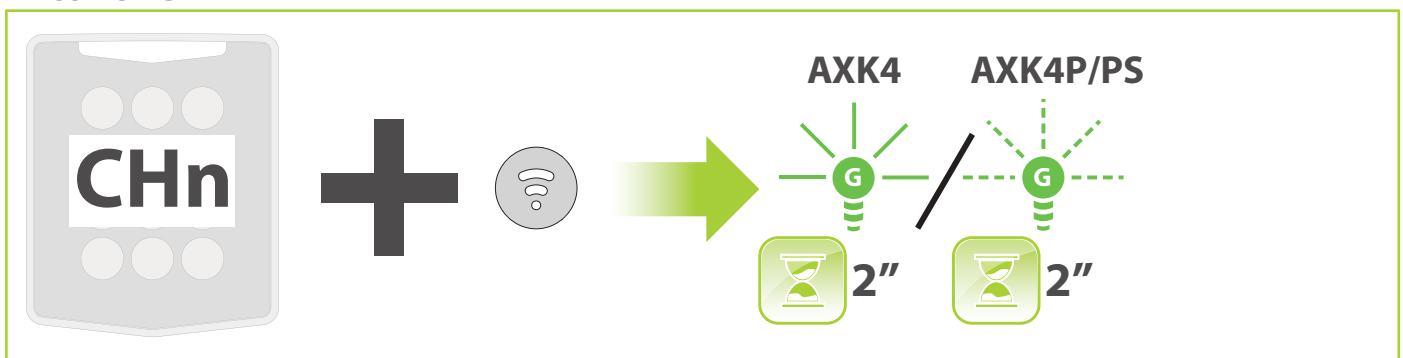

- FREIEN Kanal aktivieren (wenn konfiguriert)
- Activer Canal LIBRE (si configuré)

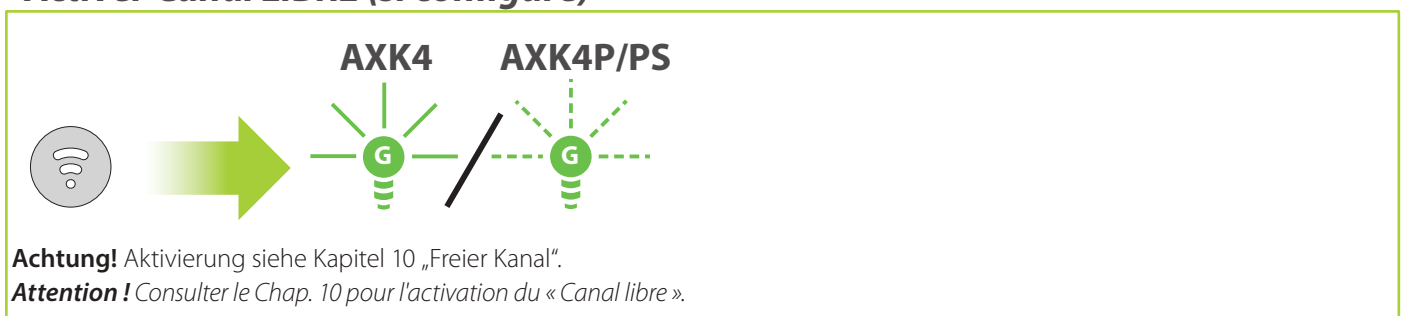

- Letzten Befehl wiederholen (innerhalb von 10 s)
- *Répéter la dernière commande (dans les 10 s)*

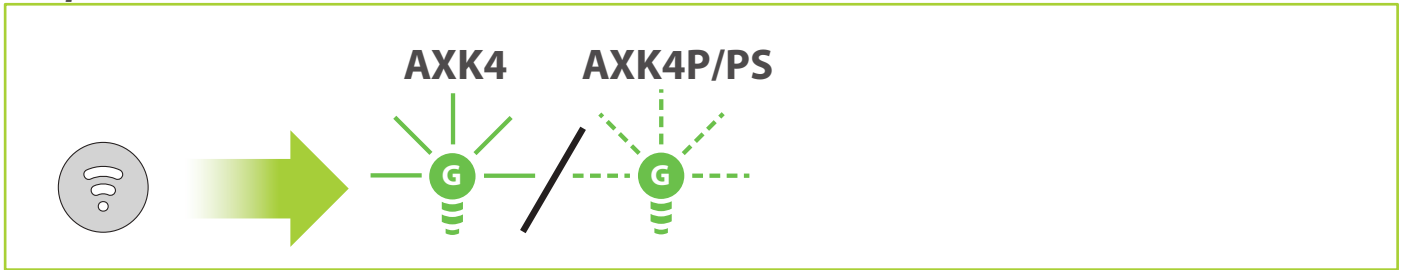

- Hintergrundbeleuchtung aktivieren
- *Activer le rétroéclairage*

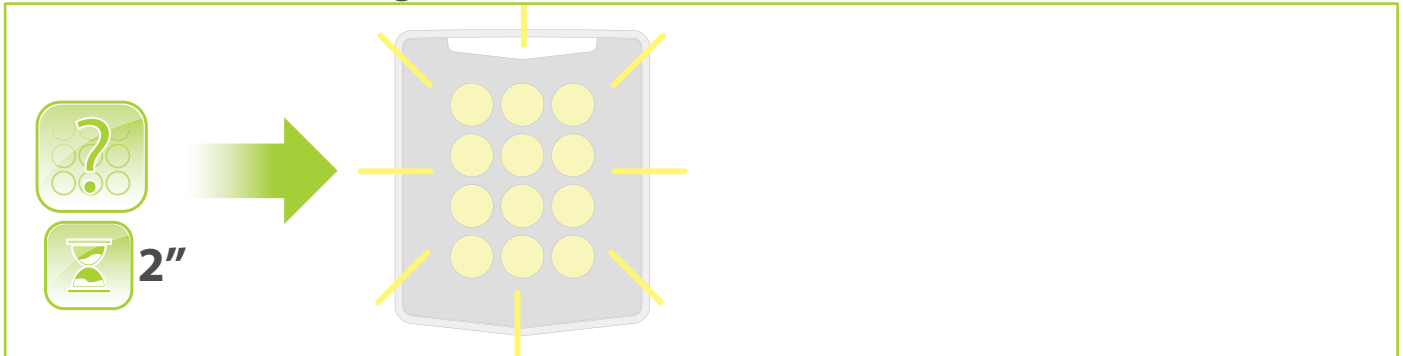

- Gerade eingegebene Sequenz löschen
- *Effacer la séquence venant d'être saisie*
- Modus „Letzten Befehl wiederholen“ verlassen
- *Quitter le mode « Répéter la dernière commande »*

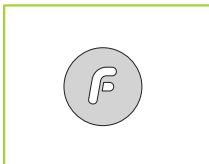

- Modellidentifikation
- *Identification du modèle*

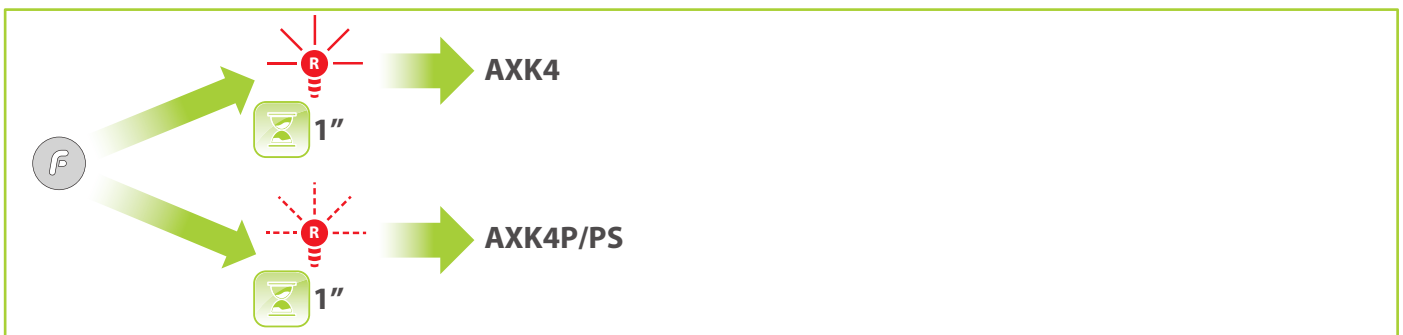

- Falsche Eingabe eines Codes
- *Saisie incorrecte d'un code*

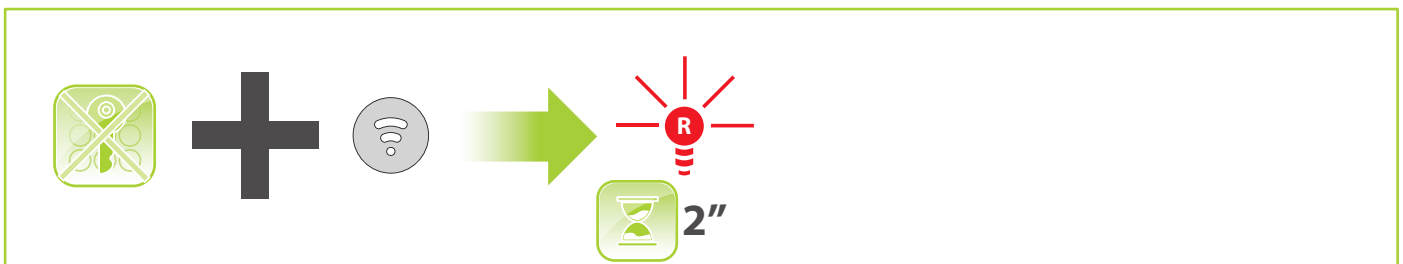

- Wiederholte Eingabe eines falschen Codes

- Saisie répétée d'un code incorrect



- Unvollständige Tasteneingaben werden nach 10 s Inaktivität ignoriert, das Gerät kehrt in den Standby-Zustand zurück.
- Die Pause zwischen dem Drücken einer Taste und der nächsten muss weniger als 5 s betragen.
- *Toute séquence de touches incomplète est ignorée au bout de 10 s d'inactivité, après quoi le produit revient à l'état de veille.*
- *La pause entre la pression d'une touche et la suivante doit être inférieure à 5 s.*

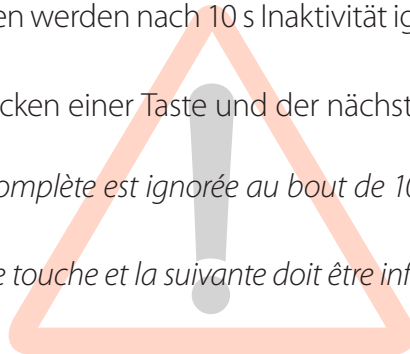

10. Sequenz für Code-Änderung

10. Séquence pour la modification des codes

- Alten Code durch einen neuen ersetzen

- Modifier l'ancien code par un nouveau

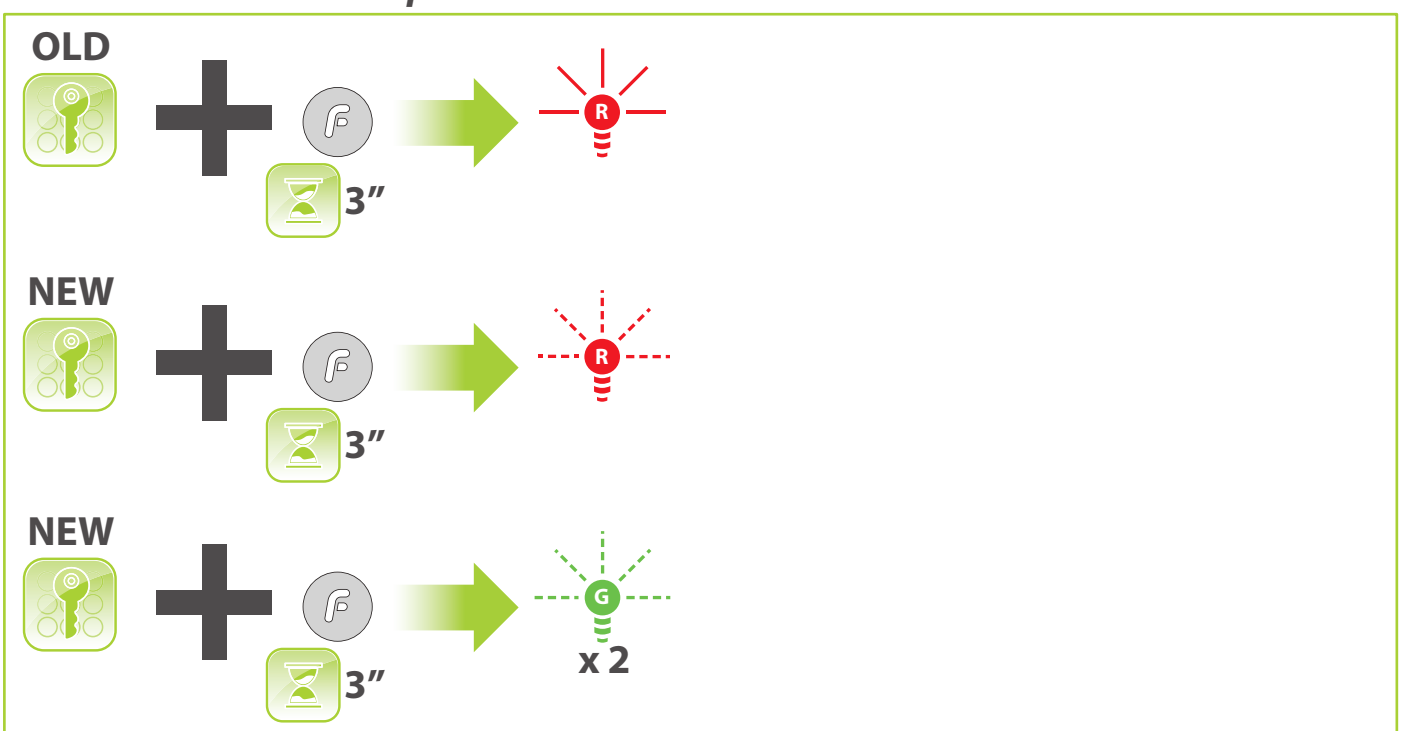

- Konfigurieren eines Codes mit „Länge Null“ (FREIER Kanal)
- Configuration d'un code de « longueur zéro » (canal LIBRE)

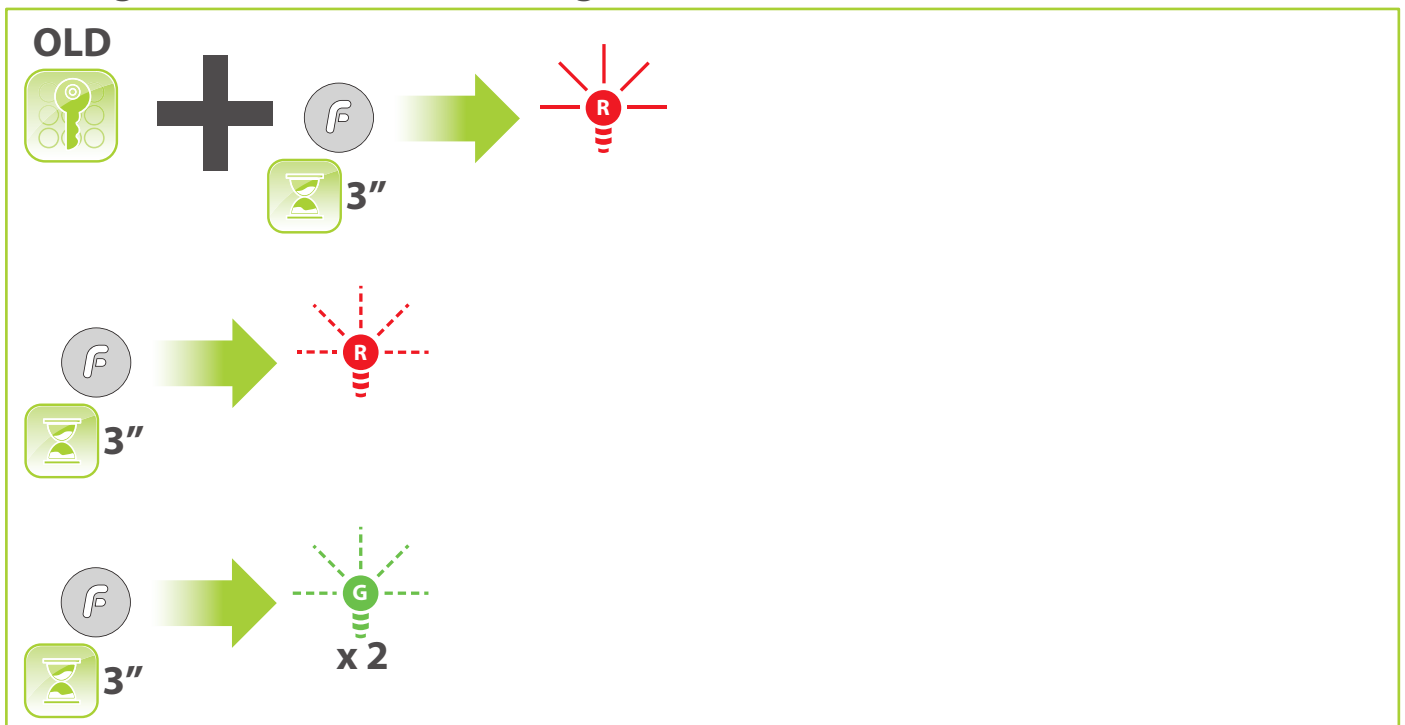

- Die Benutzercodes müssen eine Länge zwischen 0 (FREIER Kanal) und 8 Stellen haben.
- Es kann nur ein einziger Kanal als „FREIER Kanal“ konfiguriert werden.
- Folglich können die Fabrikscodes nicht verwendet werden, um anderen Kanäle als die Standardkanäle zu aktivieren (z.B. kann der Code „3333“ nicht auf CH4 verwendet werden).
- Eine unvollständige Code-Änderungssequenz wird nach 10 s Inaktivität ignoriert, das Gerät kehrt in den Standby-Zustand zurück.
- Bei einer falschen Code-Änderungssequenz leuchtet die rote LED für 3 s auf, danach kehrt das Gerät in den Standby-Zustand zurück.

- *Les codes utilisateur doivent avoir une longueur comprise entre 0 (canal LIBRE) et 8 chiffres.*
- *Un seul canal peut être configuré comme « canal LIBRE ».*
- *Par conséquent, les codes d'usine ne peuvent pas être utilisés pour activer des canaux différents de ceux qui sont prédéfinis par défaut (par exemple, le code « 3333 » ne peut pas être utilisé sur CH4).*
- *Toute séquence de modification du code incomplète est ignorée au bout de 10 s d'inactivité, après quoi le produit revient à l'état de veille.*
- *Toute séquence de modification du code incorrecte provoque l'allumage du voyant ROUGE pendant 3 s, après quoi le produit revient à l'état de veille.*

11. Stato CONFIG

11. État CONFIG



- Alten KONFIG-Code durch einen neuen ersetzen
- *Modifier l'ancien code CONFIG par un nouveau*

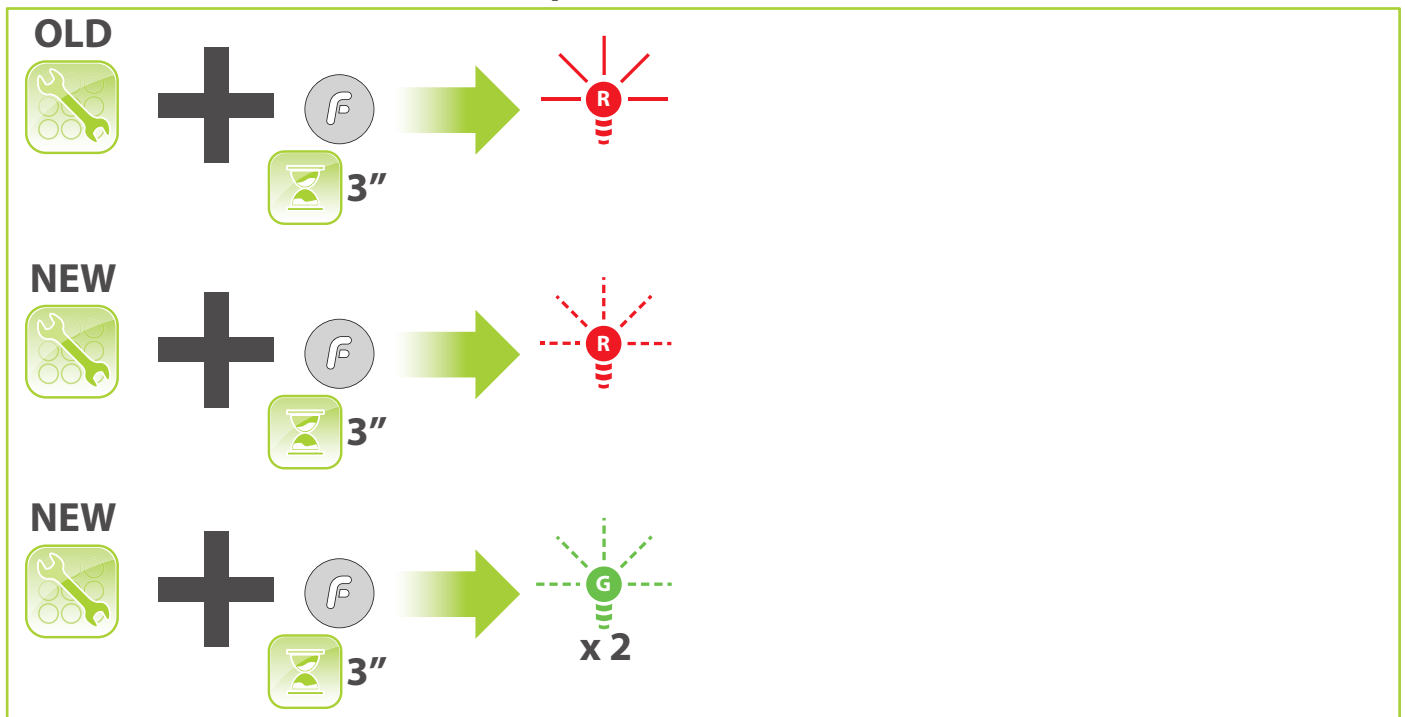

- Zugriff auf Modus KONFIG
- *Accès au mode CONFIG*

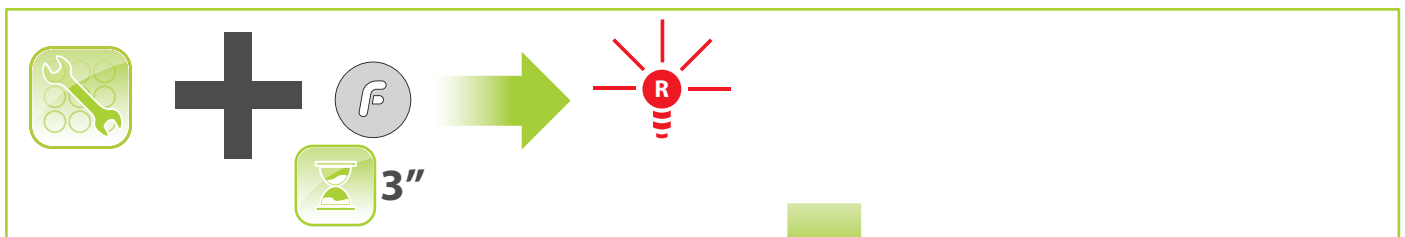

- FREIEN Kanal auf Standard zurücksetzen
- *Restaurer Canal LIBRE à l'état de défaut*

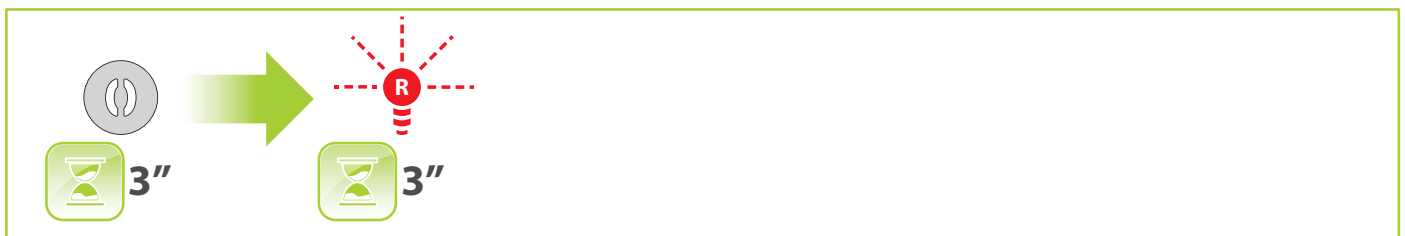

- ROLL / ENC auf CH1-CH2 schalten
- *Commuter ROLL / ENC sur CH1-CH2*

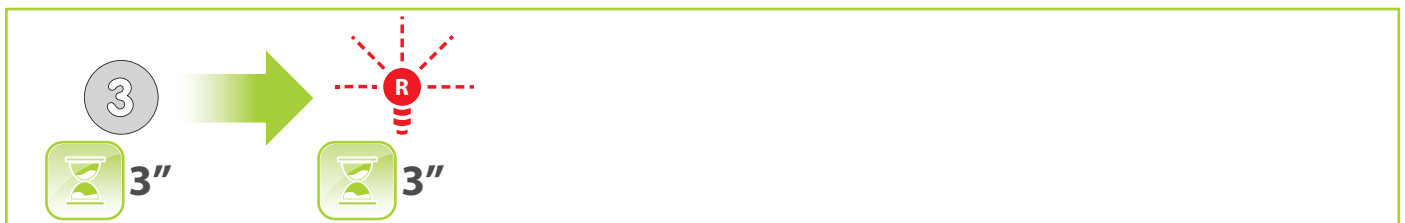



- ROLL / ENC auf CH3-CH4 schalten
- *Commuter ROLL / ENC sur CH3-CH4*

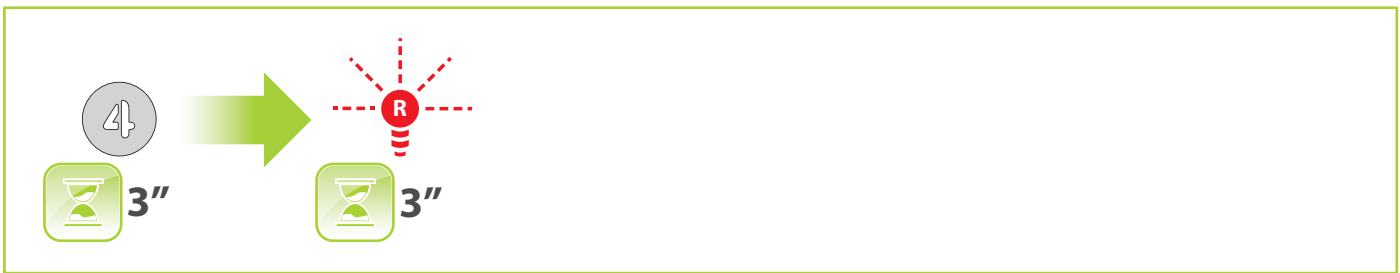

- Code-Änderungsfunktion AKTIVIEREN
- *ACTIVER la fonction modification des codes*

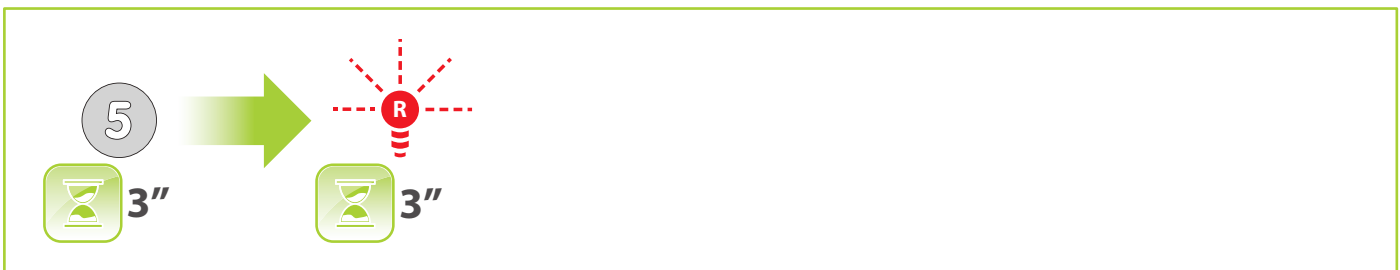

- Code-Änderungsfunktion DEAKTIVIEREN
- *DÉSACTIVER la fonction modification des codes*

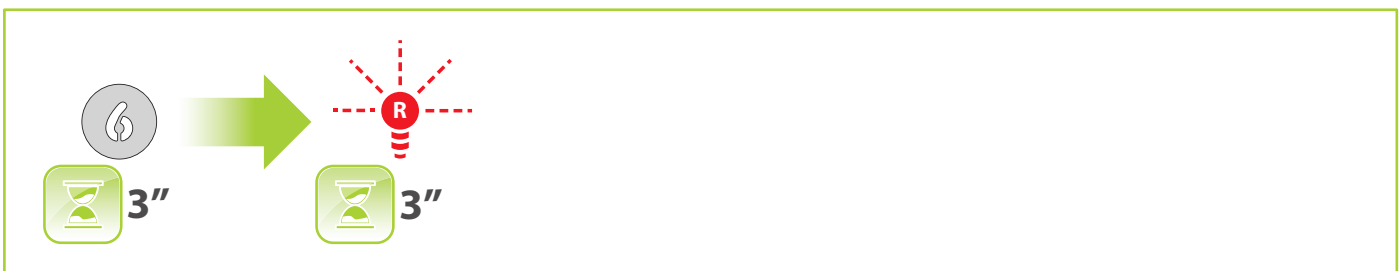

- WIEDERHERSTELLUNG Werkskonfiguration
- *RESTAURATION de la configuration d'usine*

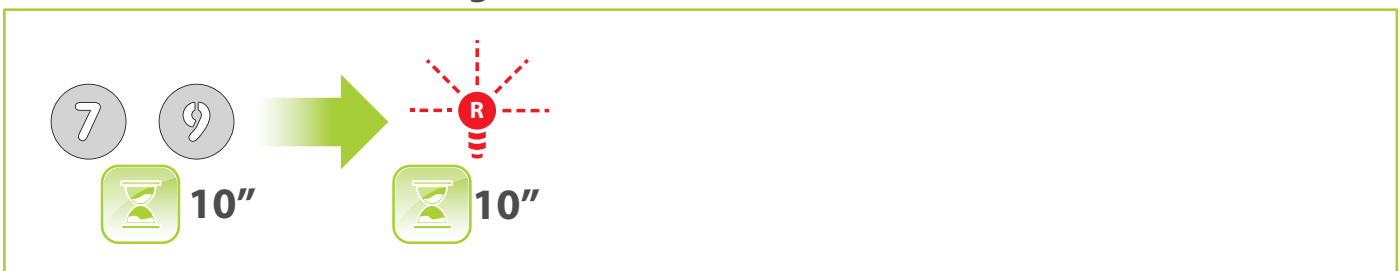

- Totale SPERRE Konfiguration
- *VERROUILLAGE total de la configuration*





- Der Konfigurationscode (KONFIG) muss zwischen 4 und 8 Stellen lang sein.
- Nachdem Sie den Konfigurationsstatus eingegeben haben, steht Ihnen eine Zeit von 30 s zur Verfügung, um den gewünschten Vorgang durchzuführen. Wird diese Zeit überschritten, ohne den laufenden Vorgang abzuschließen, kehrt das Gerät in den Standby-Zustand zurück, ohne Änderungen am Produkt vorzunehmen.
- Sobald die Totsperrung der Konfiguration aktiviert wurde, können keine Änderungen an der Konfiguration oder die Werkseinstellungen zurückgesetzt werden.
- *Le code de configuration (CONFIG) doit avoir une longueur comprise entre 4 et 8 chiffres.*
- *Une fois que l'on accède à l'état de configuration, le délai disponible pour effectuer l'opération souhaitée est de 30 s. Si ce délai est dépassé sans que l'opération en cours ne soit terminée, le produit revient à l'état de veille sans apporter aucune modification au produit.*
- *Une fois que le VERROUILLAGE total de la configuration est activé, il n'est plus possible de modifier la configuration ou d'effectuer la RESTAURATION des paramètres d'usine.*



Entrematic Group AB
Lodjursgatan 10
SE-261 44, Landskrona
Sweden
www.entrematic.com



ENTRE//MATIC

AXK4 Series



IP2292 - 018/06/08

Advertencias generales de seguridad

- Conserve estas instrucciones para futuras consultas.
- La instalación, las conexiones eléctricas y los ajustes deben ser realizadas por personal calificado, aplicando con rigor la buena técnica y respetando la normativa vigente.
- Este producto debe destinarse solamente al uso para el cual ha sido diseñado. Cualquier otro uso será considerado indebido y, por ende, peligroso. El fabricante no puede ser considerado responsable de posibles daños derivados de usos indebidos, erróneos o irrazonables del producto.
- Lea detenidamente las instrucciones antes de comenzar la instalación del producto. Una instalación incorrecta puede ser causa de peligro.
- Antes de proceder con la instalación, compruebe que el producto se encuentra en perfectas condiciones.
- No instale el producto en ambientes ni atmósferas explosivas: la presencia de gases o humos inflamables constituyen un grave peligro para la seguridad.
- Peligro de explosión si la batería se reemplaza con una de tipo incorrecto.
-  El material del embalaje (plástico, poliestireno, etc.) no se debe tirar al medio ambiente y debe mantenerse fuera del alcance de los niños porque es una potencial fuente de peligro.

Eliminación de residuos eléctricos/electrónicos



La imagen del cubo de basura tachado indica que el producto no debe formar parte de los residuos habituales del hogar. Se debe reciclar según la normativa ambiental local de eliminación de residuos. Cuando se separan los productos que llevan esta imagen, se contribuye a reducir el volumen de residuos que se incineran o se envían a vertederos y se minimiza el impacto negativo sobre la salud y el medio ambiente.

Al desechar la batería, atenerse a los reglamentos vigentes en su área de residencia. ¡La batería no puede arrojarse a la basura!

Advertências gerais para a segurança

- Conserve estas instruções para consultas futuras.
- A instalação, as ligações elétricas e as regulações devem ser efetuadas por técnicos qualificados, na observância da Boa Técnica e em respeito das normas vigentes.
- Este produto deverá ser destinado somente ao uso para o qual foi expressamente concebido. Qualquer outro uso deve ser considerado impróprio e portanto perigoso. O fabricante não pode ser considerado responsável por eventuais danos causados por usos incorretos, errados e irracionais.
- Ler atentamente as instruções antes de iniciar a instalação do produto. Uma instalação errada pode ser fonte de perigo.
- Antes de iniciar a instalação, verificar a integridade do produto.
- Não instalar o produto em ambiente e atmosfera explosivos: presença de gases ou fumos inflamáveis constituem um grave perigo para a segurança.
- Perigo de explosão se a bateria for substituída por um tipo incorreto.
-  Os materiais da embalagem (plástico, poliestireno, etc.) não devem ser abandonados no ambiente e não devem ser deixados ao alcance de crianças porque são fontes potenciais de perigo.

Eliminação de resíduos elétricos/eletrônicos



O símbolo do caixote do lixo com o sinal de proibição indica que esse artigo deve ser separado dos resíduos domésticos convencionais. Deve ser entregue para reciclagem de acordo com as regulamentações ambientais locais para tratamento de resíduos. Ao separar um artigo assinalado dos resíduos domésticos, ajuda a reduzir o volume de resíduos enviados para os incineradores ou aterros, minimizando o potencial impacto negativo na saúde pública e no ambiente.

Ao descartar a bateria, siga os regulamentos em vigor na sua área de residência. A bateria não pode ser descartada no lixo doméstico!



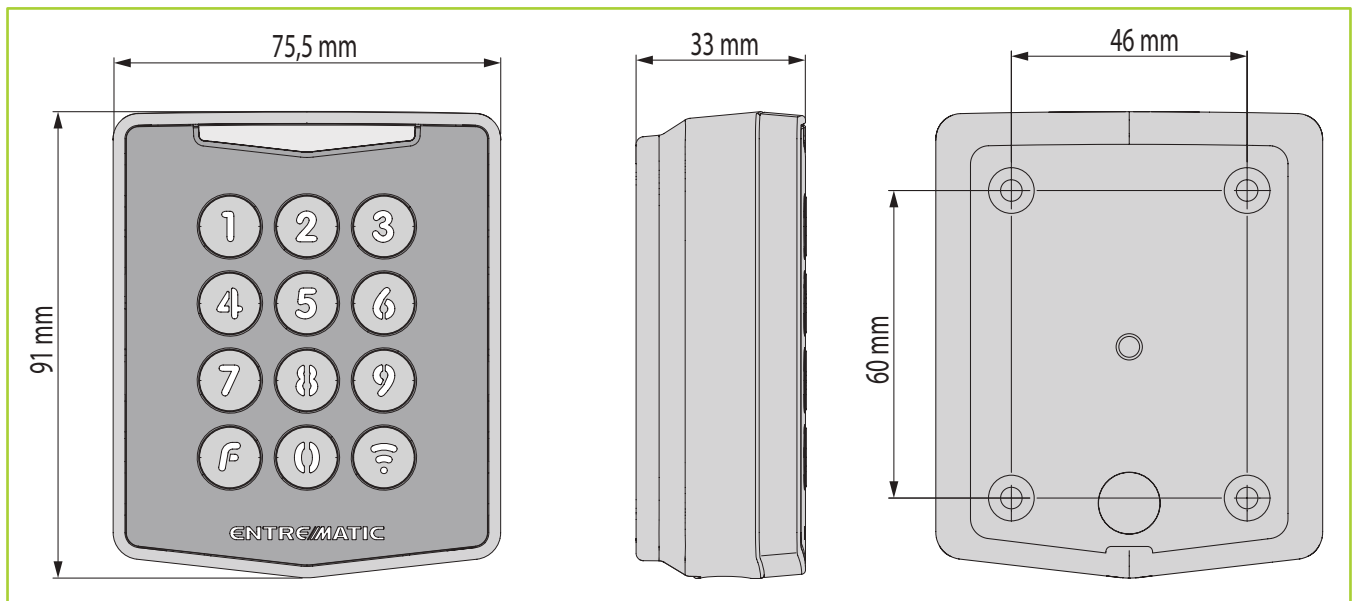

1. Dimensiones

1. Dimensões



2. Datos técnicos

2. Dados técnicos

	AXK4	AXK4P/PS
Frecuencias operativas <i>Frequências operativas</i>	433,92 MHz	868,35 MHz
Potencia radiada <i>Potência irradiada</i>	< 1 mW	< 1 mW
Protocolo de transmisión <i>Protocolo de transmissão</i>	Rolling code data frame (puede cambiarse con AES-128) (pode ser trocado por AES-128)	AES-128 encrypted data frame (puede cambiarse con Rolling code) (pode ser trocado por Rolling code)
Canales disponibles <i>Canais disponíveis</i>	Cuatro (CH1, CH2, CH3, CH4), activados con cuatro códigos numéricos distintos. <i>Quatro (CH1, CH2, CH3, CH4), ativados mediante quatro códigos numéricos diferentes.</i>	
Distancia <i>Distância</i>	50 m - 150 m (exterior, en línea recta) / (exterior, em linha reta)	
Alimentación <i>Alimentação</i>	9 volt alkaline battery, 6LR61	 LITHIUM LITHIUM ION
Alimentación externa [*] <i>Alimentação externa</i> [*] 	12 - 24 volt DC	
Grado de protección <i>Grau de proteção</i>	IP55	
Intervalo de temperatura de uso (°C) <i>Faixa de temperatura de utilização</i> (°C)	 -20°C -  +50°C	
Peso <i>Peso</i>	165 g	

¡Atención! Las baterías agotadas deben depositarse en los contenedores RAEE dedicados o en los centros de recogida adecuados.

Atenção! As baterias gastas devem ser eliminadas em recipientes RAEE apropriados ou em centros de coleta adequados.

[*] **¡Advertencia!** Asegúrese de desconectar la batería interna cuando se utilice la alimentación externa.

La alimentación externa debe usarse solo **como alternativa** a la interna.

[*] **Advertência!** Desconecte sempre a bateria interna ao utilizar a alimentação externa.

A alimentação externa deve ser utilizada somente quando não é usada a alimentação interna.



3. Declaración UE de conformidad

3. Declaração UE de conformidade

El fabricante Entrematic Group AB, con sede en Lodjursgatan 10, SE-261 44 Landskrona, Suecia, declara que los productos AXK4, AXK4P y AXK4PS son conformes con los requisitos esenciales y otras disposiciones pertinentes de la Directiva 2014/53/UE RED.

O fabricante, Entrematic Group AB, com sede em Lodjursgatan 10, SE-261 44 Landskrona, Suécia, declara que os produtos AXK4, AXK4P e AXK4PS são conformes aos requisitos essenciais e às outras disposições pertinentes da Diretiva 2014/53/UE RED.

Landskrona, 2018-05-02



Matteo Fino

(President Entrematic Itay S.p.A.)

4. Uso previsto

4. Utilização prevista

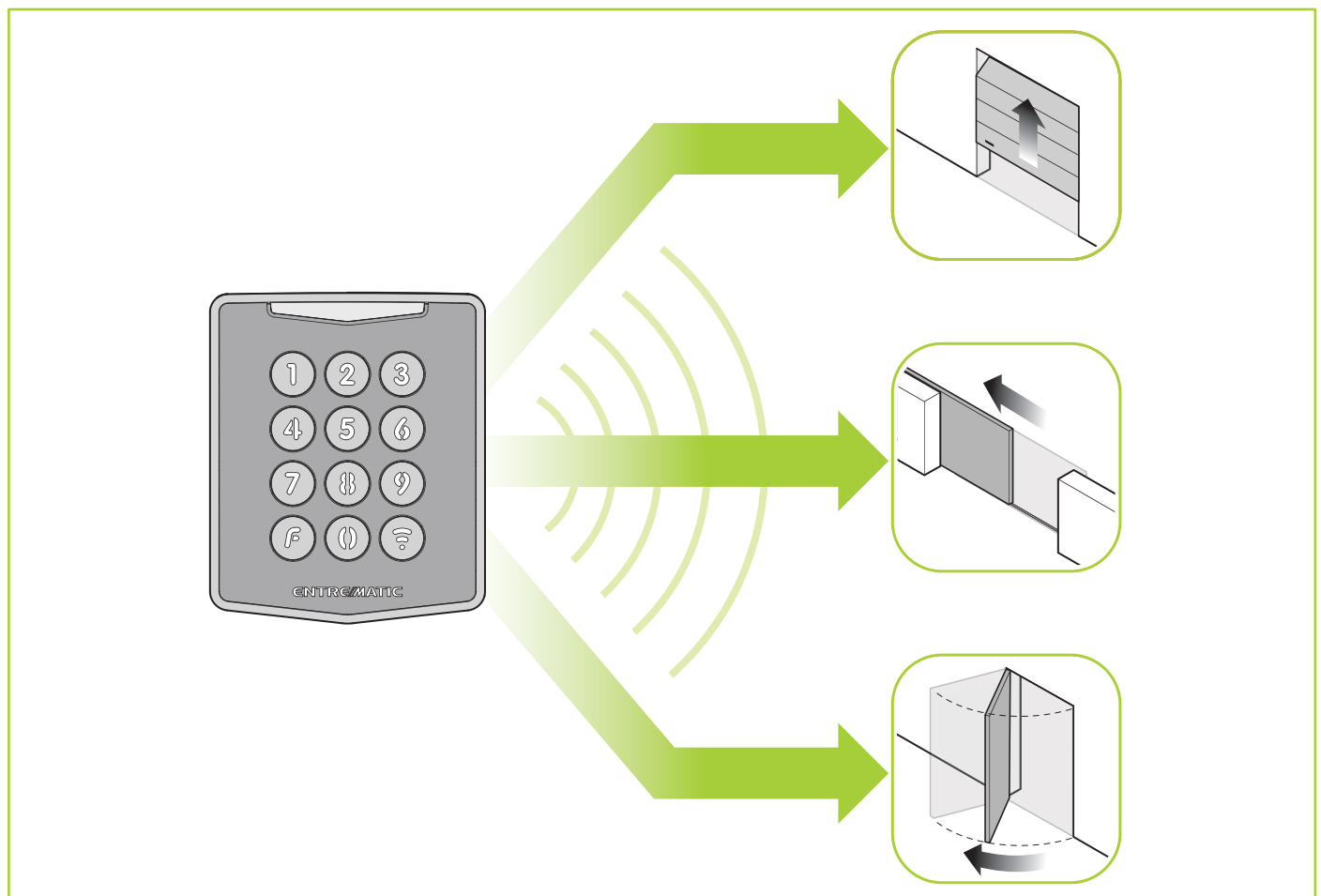

5. Fases de instalación

5. Fases de instalação

STEP 1

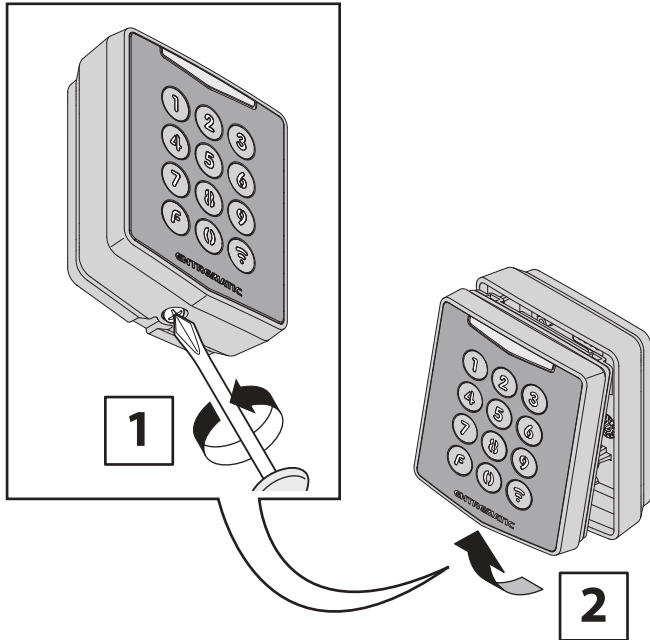

STEP 2

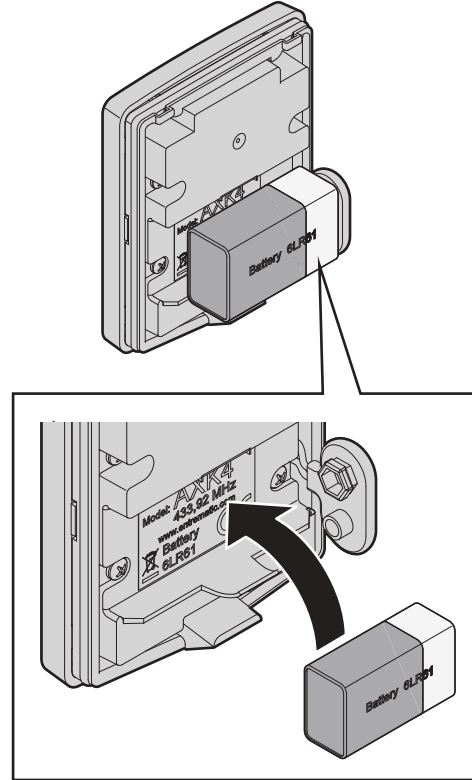

STEP 3

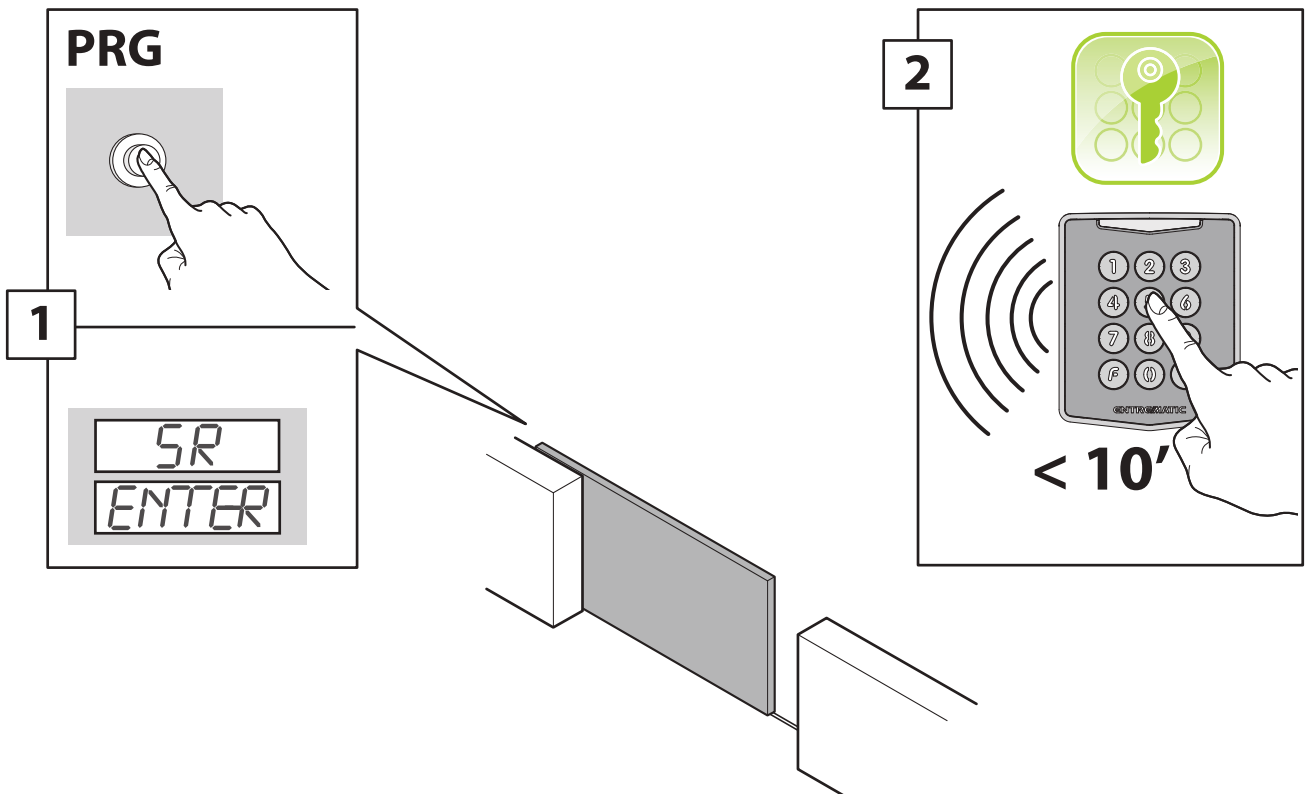

STEP 4

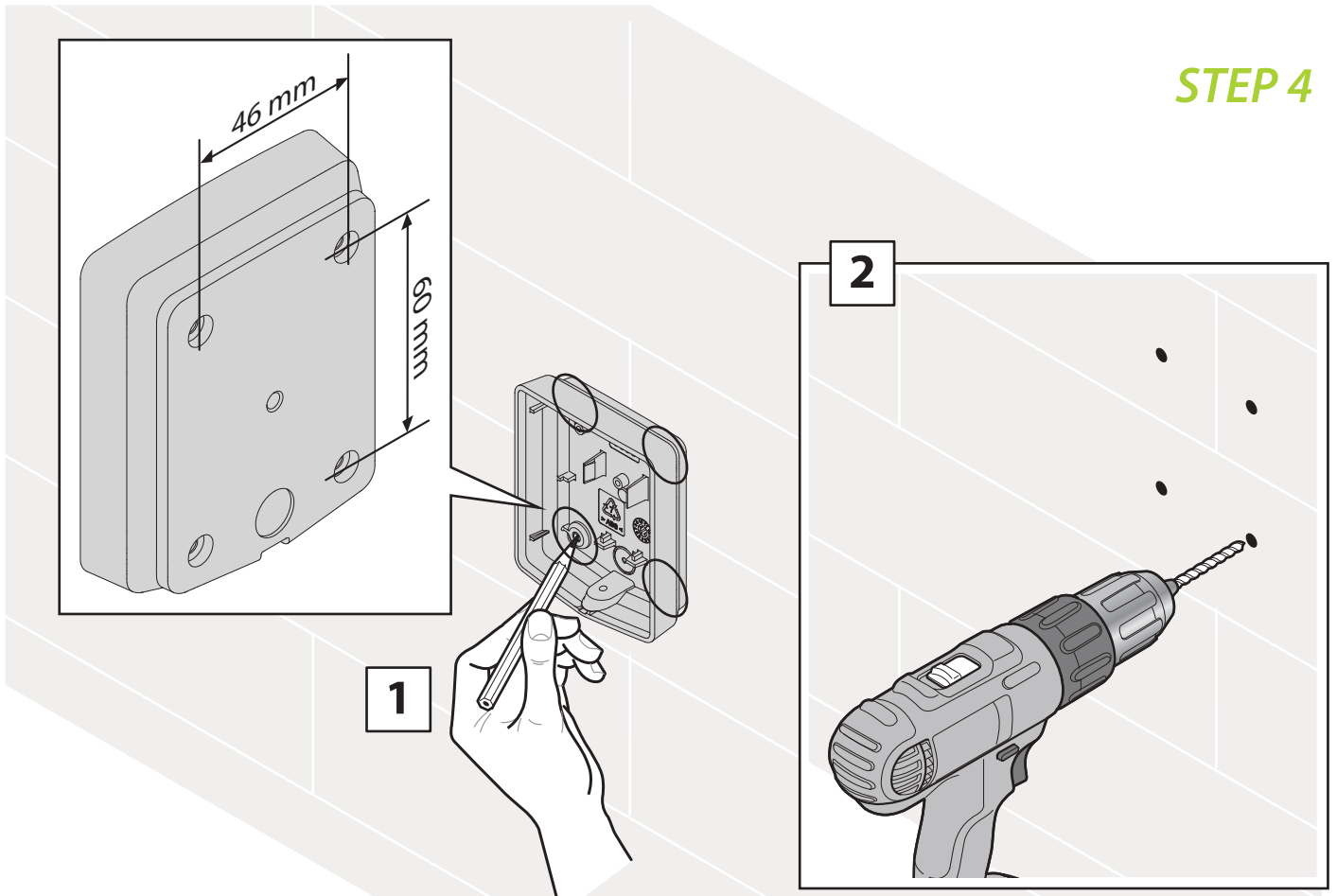

STEP 5

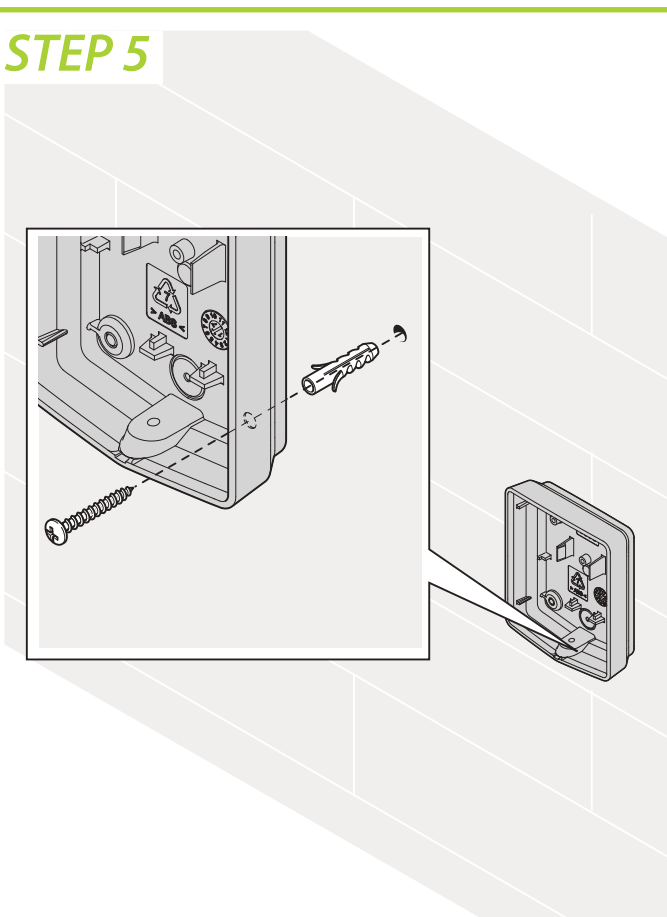

STEP 5A



Solo para alimentación externa.
Apenas para alimentação externa.



STEP 6



Solo para alimentación externa.
Apenas para alimentação externa.

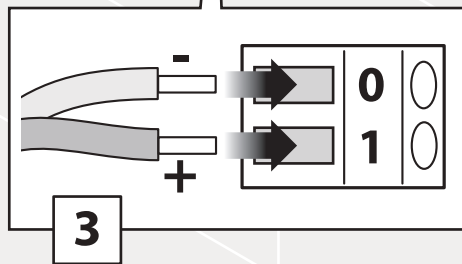
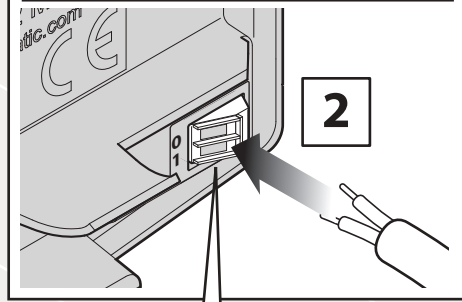
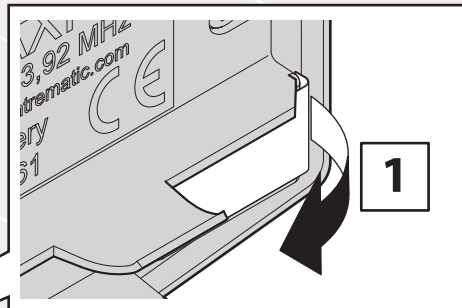
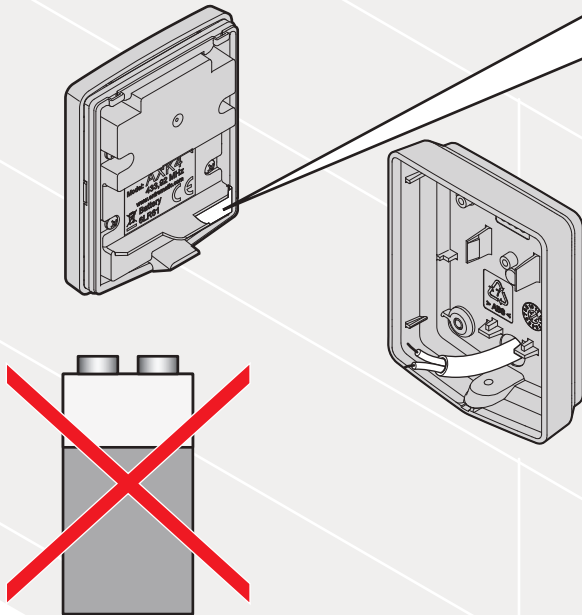

STEP 7

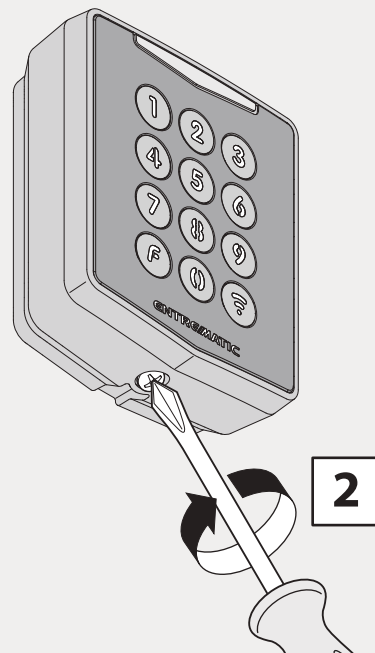
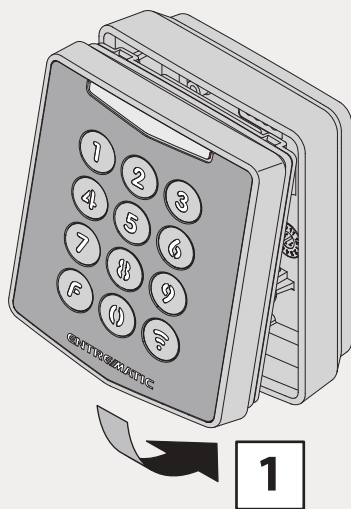

6. Sustitución de batería

6. Substituição da bateria

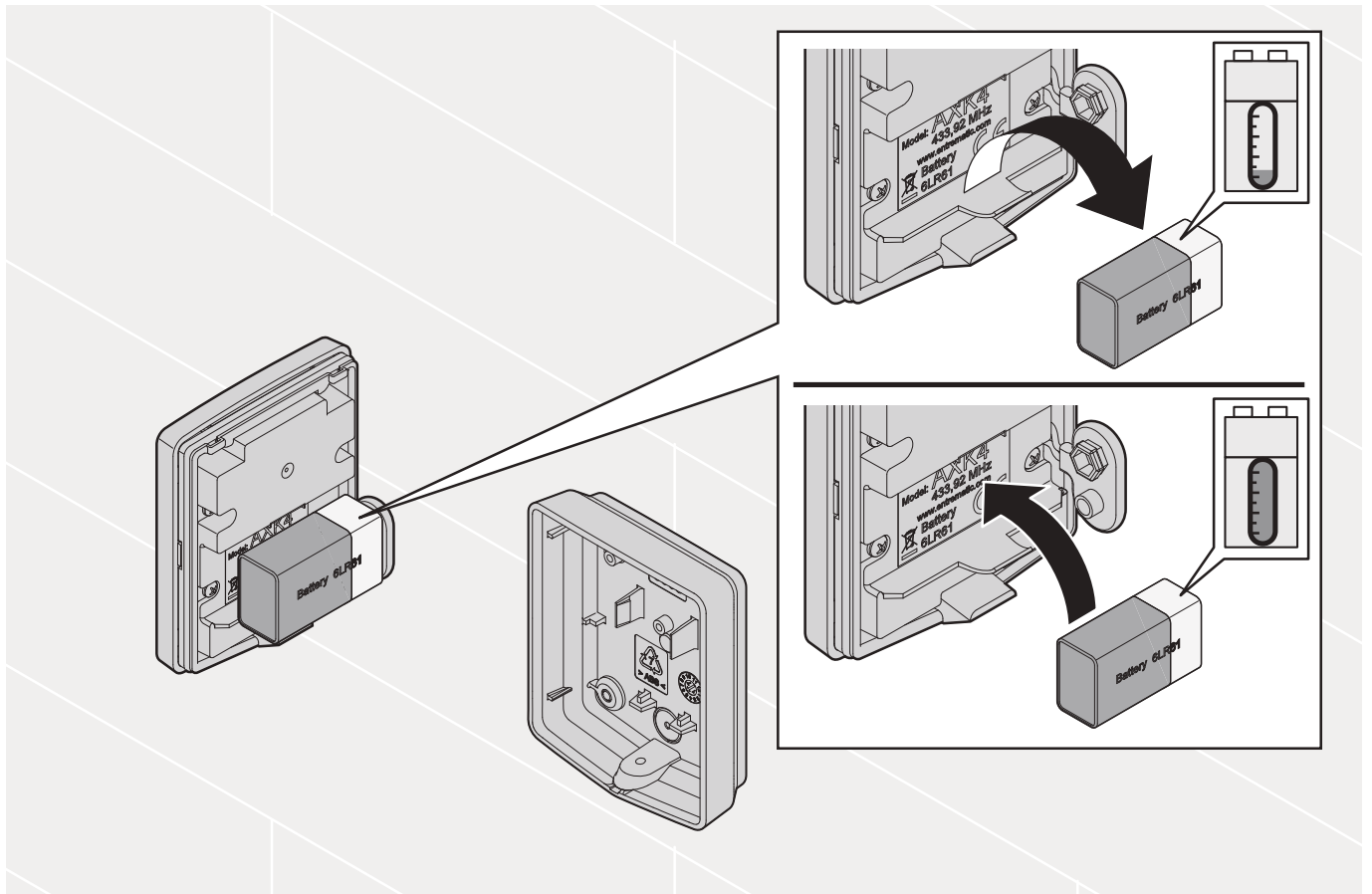

7. Descripción de iconos

7. Descrição dos ícones



Configuración de fábrica
Configurações de fábrica



Código de configuración
Código de configuração



Desbloqueo del equipo
Desbloqueio do aparelho



Bloqueo del equipo
Bloqueio do aparelho



Lapso de tiempo
Intervalo de tempo



Código
Código



Luz verde fija
Luz verde fixa



Luz verde intermitente
Luz verde intermitente



Luz roja fija
Luz vermelha fixa



Luz roja intermitente
Luz vermelha intermitente

CH

Canal (1, 2, 3, 4)
Canal (1, 2, 3, 4)



Cualquier tecla, excepto
Tecla qualquer, exceto



Solo para personal cualificado
Apenas pessoal qualificado



Código incorrecto
Código errado

8. Códigos de fábrica

8. Códigos de fábrica

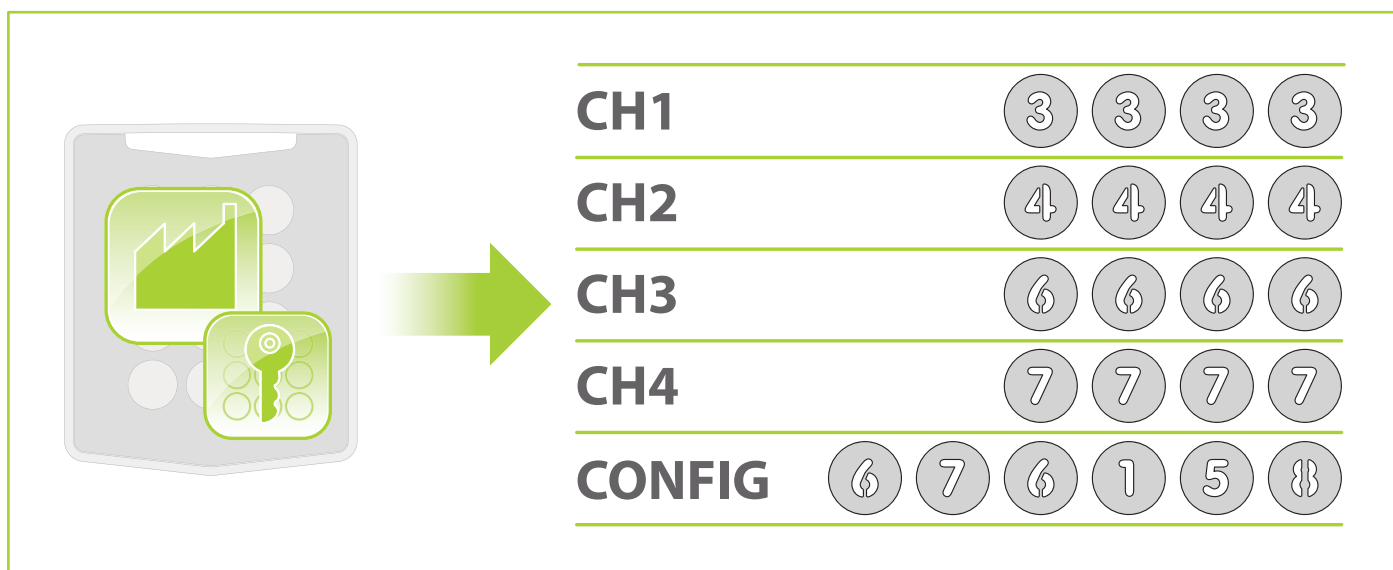

9. Secuencias de mando básicas

9. Sequências de comandos de base

- Activar CHn

- Ativar CHn

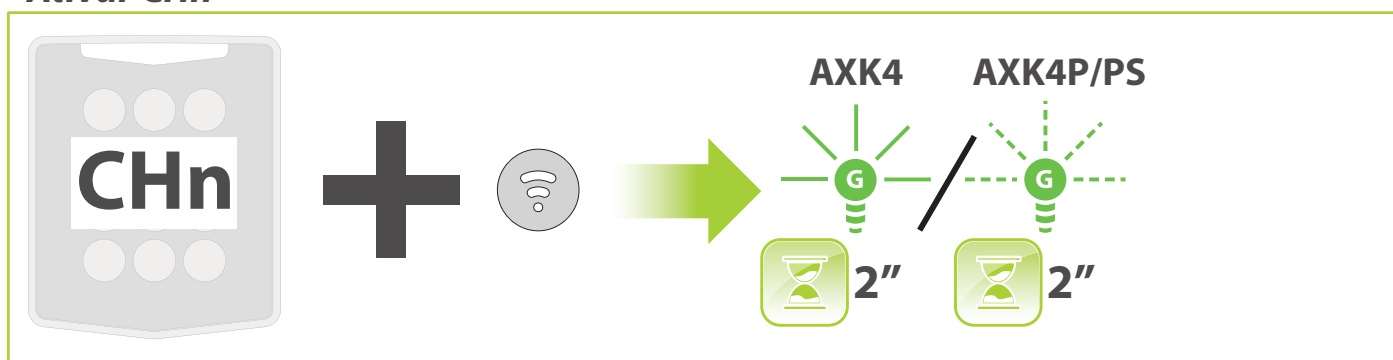

- Activar Canal LIBRE (si está configurado)

- Ativar Canal LIVRE (se configurado)



- Repetir el último mando (antes de 10 s)
- *Repetir o último comando (dentro de 10 s)*

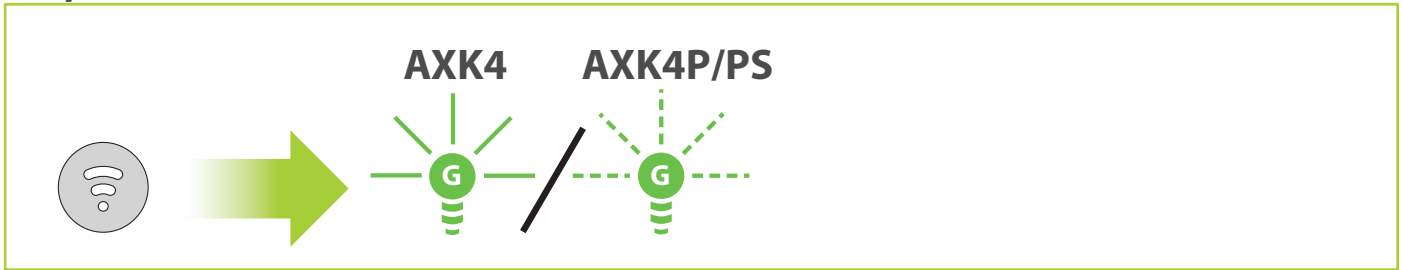

- Activar la retroiluminación
- *Ativar a retroiluminação*

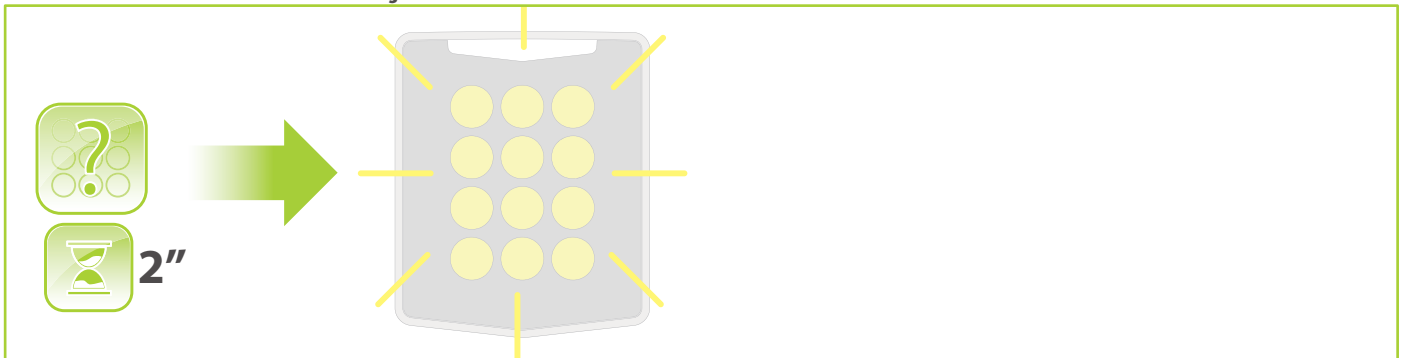

- Eliminar la secuencia que acaba de introducirse
- *Cancelar a sequência que acabou de digitar*
- Salir del modo "Repetir el último mando"
- *Sair da modalidade "Repetir o último comando"*

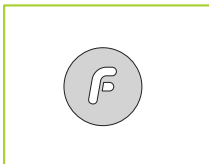

- Identificación del modelo
- *Identificação do modelo*

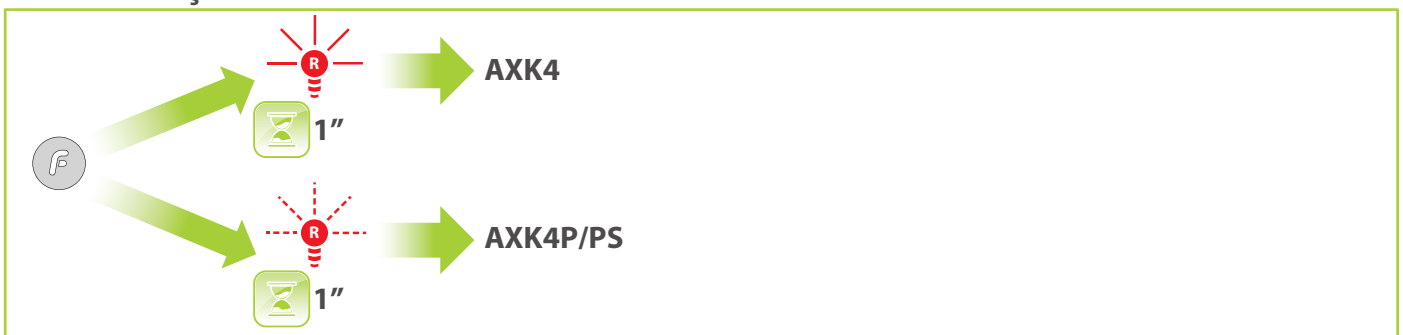

- Introducción incorrecta de un código
- *Digitação errada de um código*

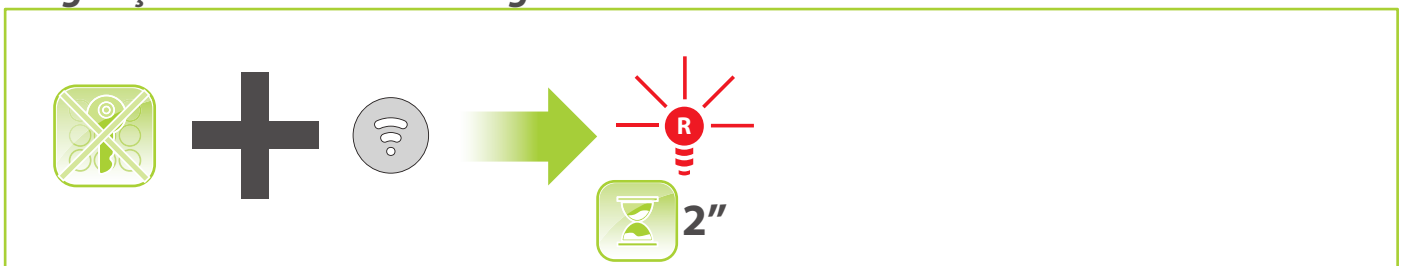

- Introducción repetida de un código incorrecto

- Digitação repetida do código errado



- Cualquier secuencia de teclas incompleta se ignora después de 10 s de inactividad y se vuelve al estado de stand-by.
- La pausa entre la presión de una tecla y la siguiente debe ser inferior a 5 s.
- *Qualquer sequência de teclas incompleta é ignorada depois de 10 s sem atividades, retornando à condição de stand-by.*
- *A pausa entre a pressão de uma tecla e a pressão sucessiva deve ser inferior a 5 s.*

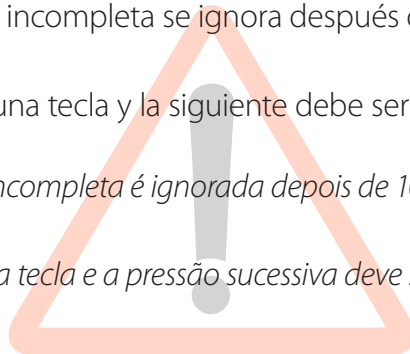

10. Secuencia para cambio de códigos

10. Sequência para a troca dos códigos

- Cambiar el código antiguo por uno nuevo

- Trocar o código antigo por um novo código

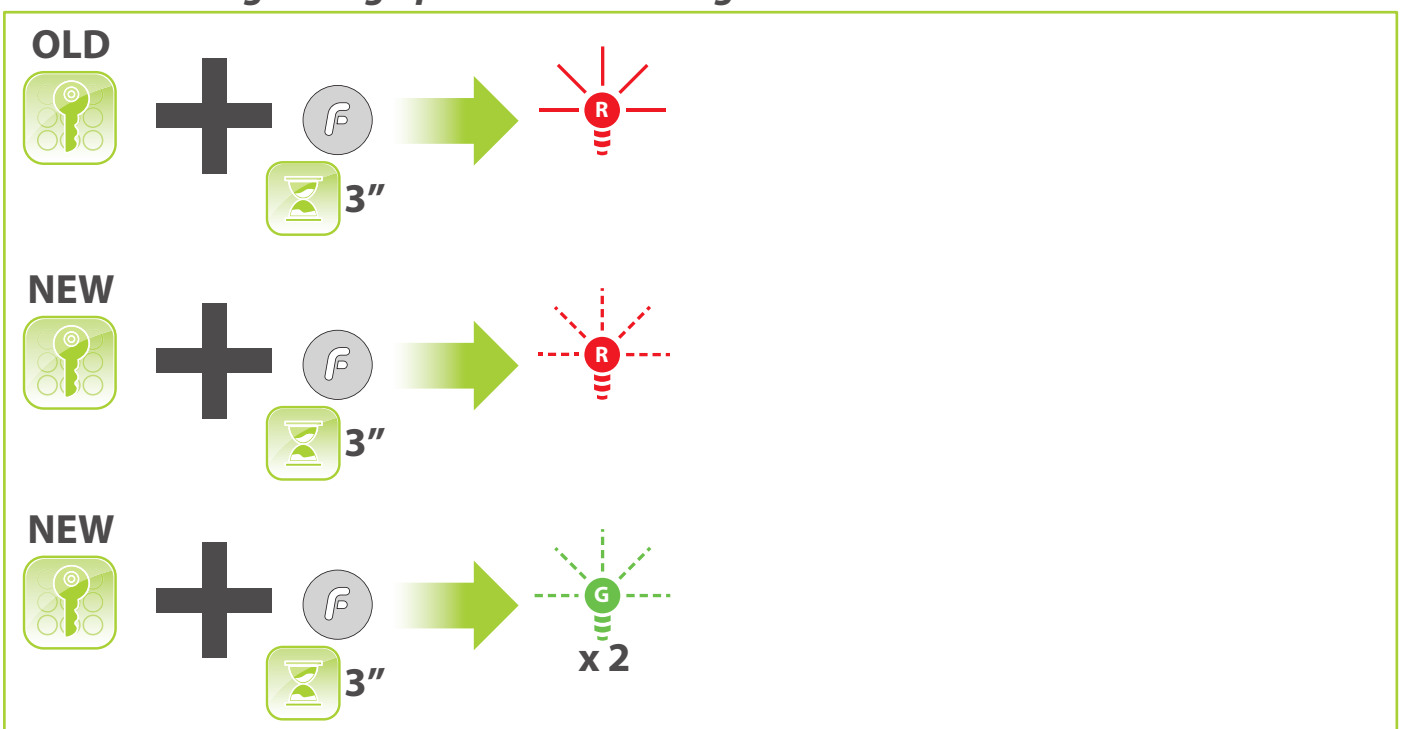

- Configuración de un código de "longitud cero" (Canal LIBRE)

- Configuração de um código com "comprimento zero" (Canal LIVRE)

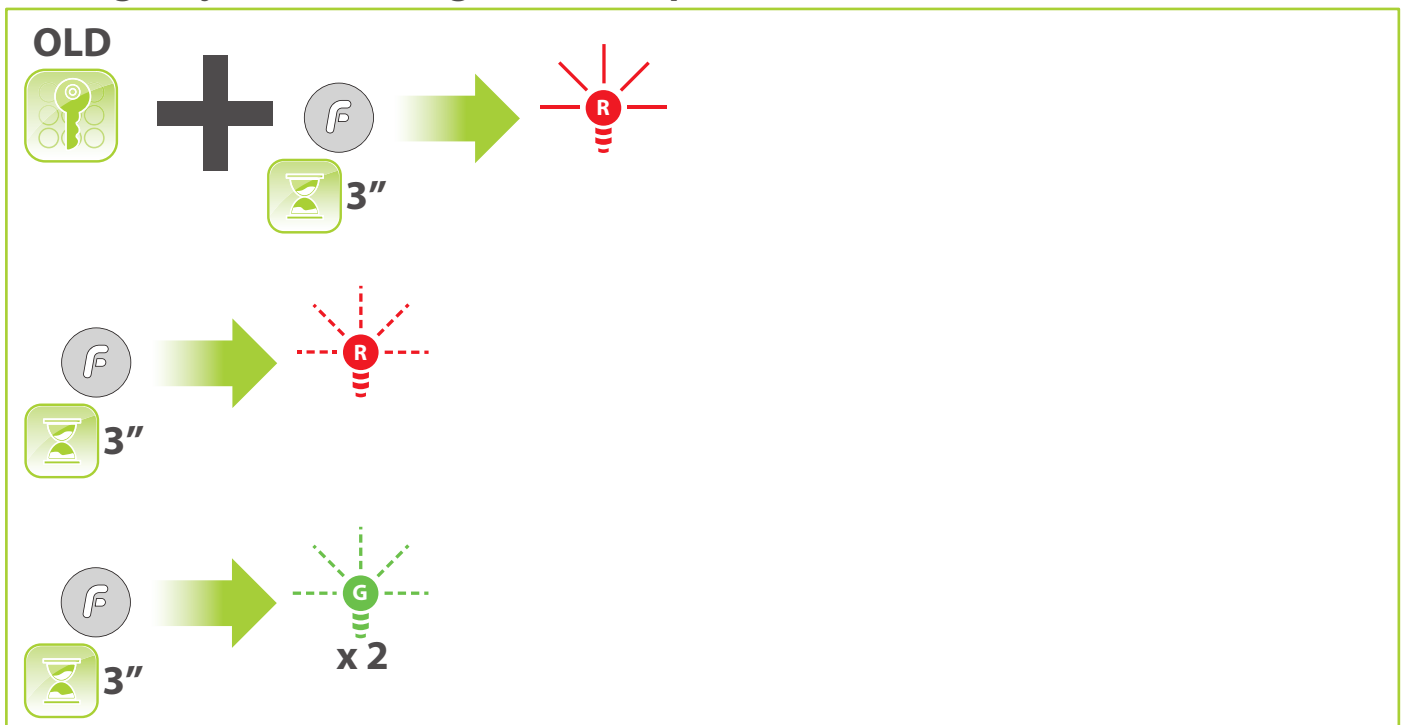

- Los códigos de usuario deben tener una longitud entre 0 (canal LIBRE) y 8 cifras.
- Solo puede configurarse un canal como "Canal LIBRE".
- Por consiguiente, los códigos de fábrica no pueden usarse para activar canales distintos de los predefinidos (por ejemplo, el código "3333" no puede usarse en el CH4).
- Cualquier secuencia de cambio de código se ignora después de 10 s de inactividad y se vuelve al estado de stand-by.
- Una secuencia de cambio de código incorrecta provoca el encendido del LED ROJO durante 3 s, y después el producto vuelve al estado de stand-by.

- *Os códigos do utilizador devem ter um comprimento entre 0 (canal LIVRE) e 8 dígitos.*
- *Somente um único canal pode ser configurado como "Canal LIVRE".*
- *Portanto, os códigos de fábrica não podem ser utilizados para ativar canais diversos dos canais predefinidos (por exemplo, o código "3333" não pode ser usado no CH4).*
- *Uma sequência de troca de código incompleta é ignorada depois de 10 s sem atividades, retornando à condição de stand-by.*
- *Uma sequência de troca de código errada faz o LED VERMELHO acender durante 3 s e, depois disso, o produto retorna à condição de stand-by.*

11. Stato CONFIG**11. Estado CONFIG**

- Cambiar el código antiguo CONFIG por uno nuevo
- Trocar o código CONFIG antigo por um novo código

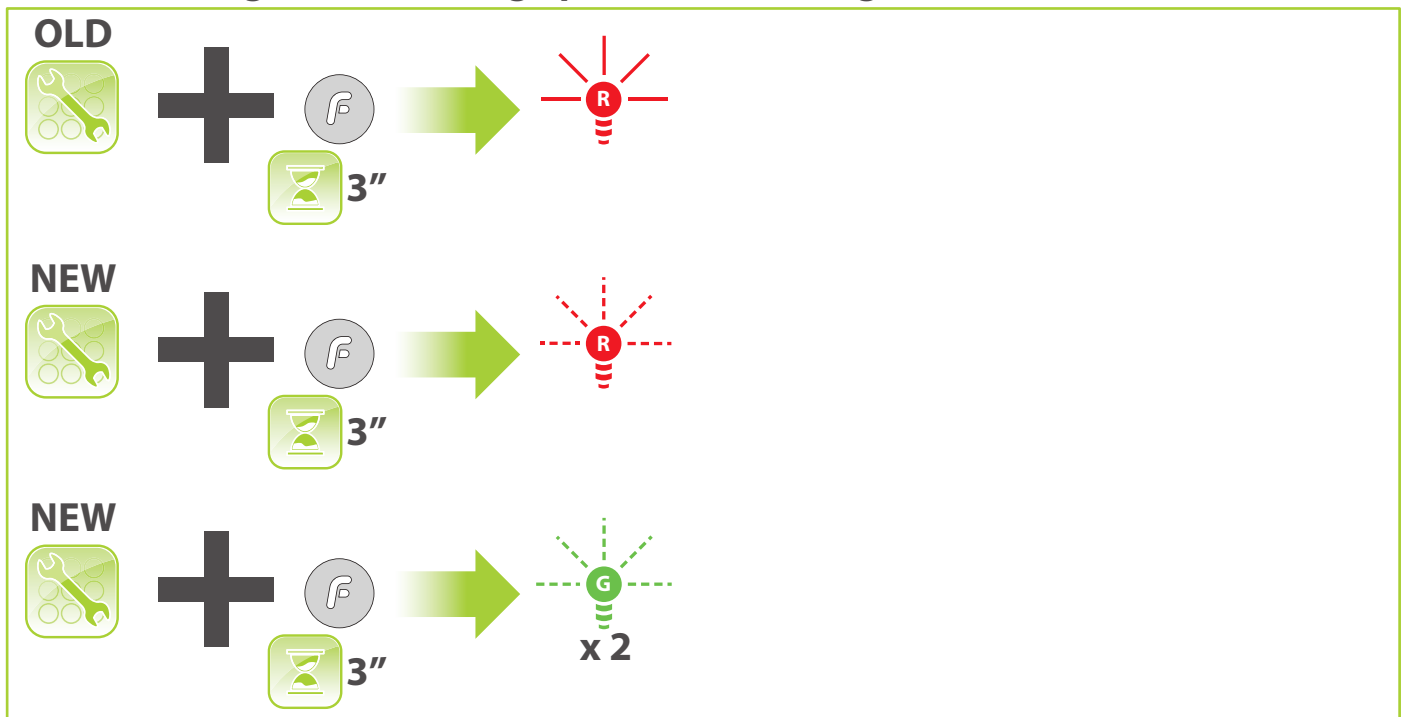

- Acceso al modo CONFIG
- Entrar na modalidade CONFIG

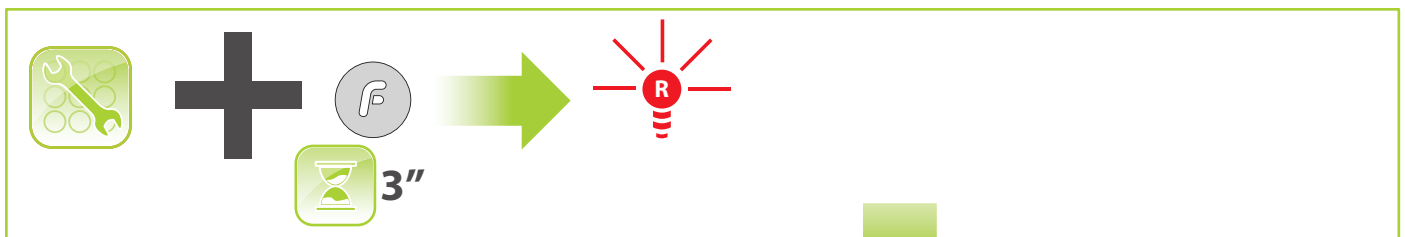

- Restablecer el Canal LIBRE a predeterminado
- Restabelecer o Canal LIVRE predefinido

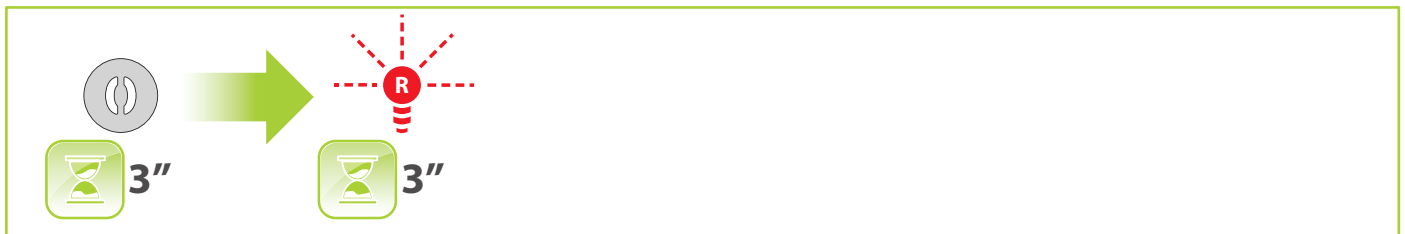

- Conmutar ROLL / ENC a CH1-CH2
- Comutar ROLL / ENC nos CH1-CH2

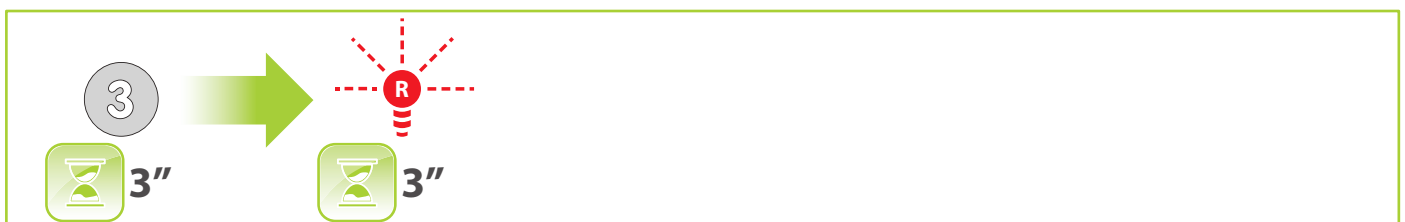



- Conmutar ROLL / ENC a CH3-CH4
- Comutar ROLL / ENC nos CH3-CH4

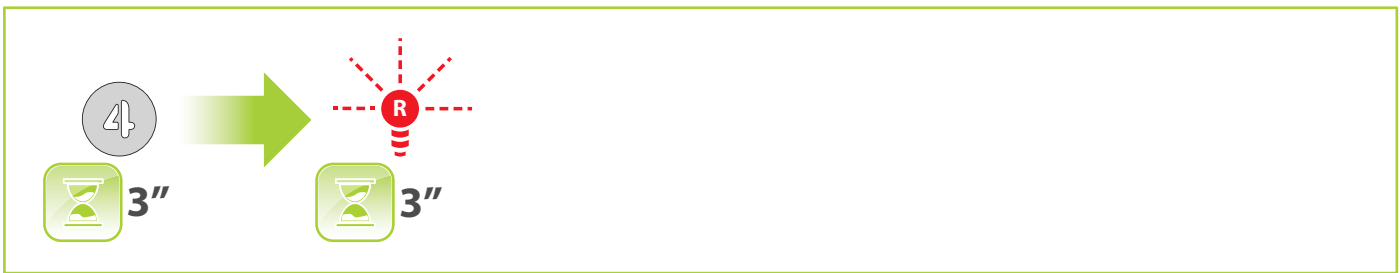

- HABILITAR función cambio de códigos
- HABILITAR a função de troca dos códigos

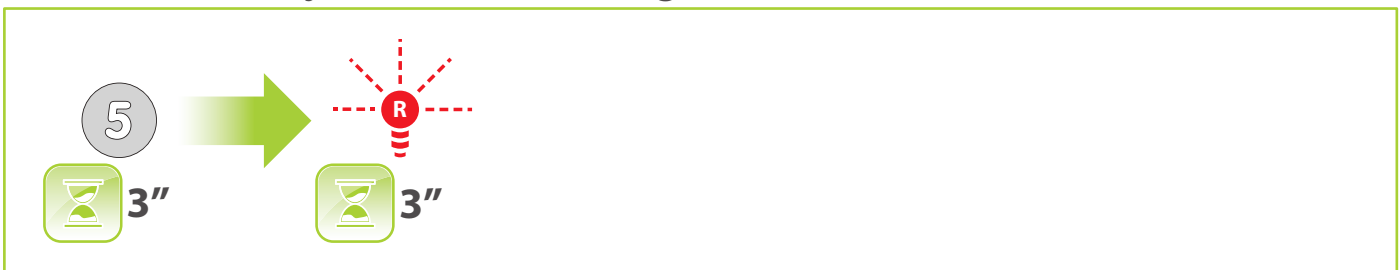

- DESHABILITAR función cambio de códigos
- DESABILITAR a função de troca dos códigos

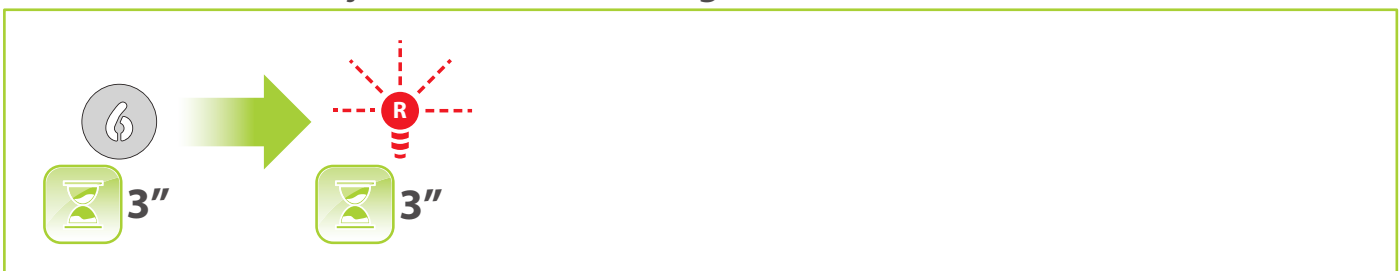

- RESTABLECIMIENTO de configuración de fábrica
- RESTABELECIMENTO da configuração de fábrica

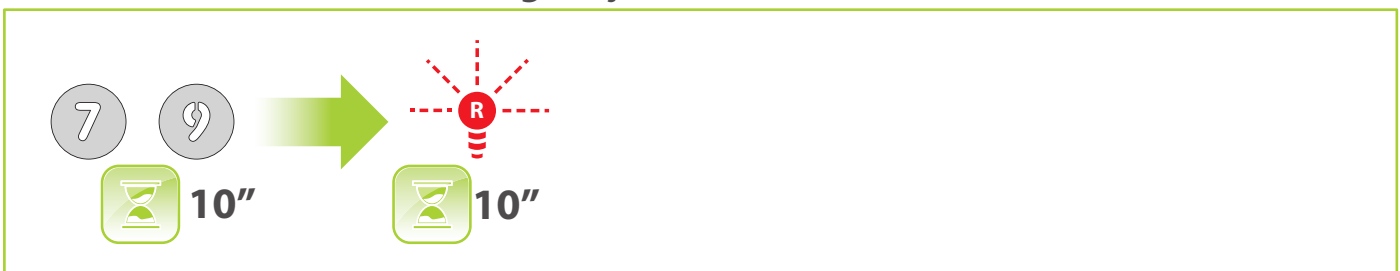

- BLOQUEO total de configuración
- BLOQUEIO total da configuração





- El código de configuración (CONFIG) debe tener una longitud entre 4 y 8 cifras.
- Una vez que se accede al estado de configuración, el tiempo disponible para efectuar la operación deseada es de 30 s. Si se supera este tiempo sin concluir la operación en curso, el producto vuelve al estado de stand-by sin efectuar ningún cambio en el producto.
- Una vez activado el BLOQUEO total de la configuración, ya no es posible efectuar ninguna modificación en la configuración o el RESETEO de fábrica.
- *O código de configuração (CONFIG) deve ter um comprimento entre 4 e 8 dígitos.*
- *Depois de entrar no estado de configuração, o tempo disponível para efetuar a operação desejada é de 30 s. Se este intervalo de tempo for superado antes de concluir a operação, o produto retorna à condição de stand-by sem realizar nenhuma alteração no produto.*
- *Depois de ativar o BLOQUEIO total da configuração, não será mais possível realizar qualquer modificação da configuração ou o RESET de fábrica.*



Entromatic Group AB
Lodjursgatan 10
SE-261 44, Landskrona
Sweden
www.entromatic.com



ENTRE//MATIC

AXK4 Series



IP2292 - 018/06/08

Allmänna säkerhetsanvisningar

- Spara dessa instruktioner för framtida referens.
- Installationen, de elektriska anslutningarna och inställningarna får endast utföras av kunnig personal, i enlighet med god teknisk praxis och i överensstämmelse med gällande bestämmelser.
- Denna produkt ska endast användas för det syfte den är avsedd för. All annan användning är olämplig och därmed farlig. Tillverkaren kommer inte att anses ansvarig för eventuella skador som förorsakas av olämplig, felaktig eller oskälig användning.
- Läs instruktionerna noggrant innan du påbörjar installation av produkten. En felaktig installation kan ge upphov till fara för användarna.
- Kontrollera att produkten är hel innan du påbörjar installationen.
- Installera inte produkten i miljöer eller områden med explosionsrisk: närvaro av gas eller lättantändliga ångor utgör en allvarlig säkerhetsrisk.
- Explosionsrisk om batteriet byts ut med felaktig typ.
-  Förpackningsmaterialen (plast, polystyren etc) ska inte slängas i miljön och får inte placeras inom räckhåll för barn, då detta kan ge upphov till fara.

Bortskaffande av elektriskt och elektroniskt avfall



Symbolen med den överkorsade soptunnan betyder att produkten ska kasseras separat från hushållsavfall. Produkten ska lämnas in för återvinning enligt lokala regler för avfallshantering. Genom att kassera en märkt produkt separat från hushållsavfallet bidrar du till att reducera mängden avfall som skickas till förbränning eller deponi och minimerar varje potentiell negativ påverkan på mänsklig hälsa och miljön.

För bortskaffande av batteriet, följ gällande bestämmelser i ditt bostadsområde. Batteriet får inte kastas som hushållsavfall!

Generelle sikkerhedsadvarsler

- Opbevar disse instruktioner for fremtidig reference.
- Installation, elektriske tilslutninger og justeringer skal udføres af kvalificeret personale, i overensstemmelse med god teknisk praksis og i overensstemmelse med gældende bestemmelser.
- Dette produkt må kun bruges til det formål, det udtrykkeligt er designet til. Enhver anden brug betragtes som forkert og derfor farlig. Fabrikanten kan ikke holdes ansvarlig for skader forårsaget af ukorrekt, fejlagtig eller urimelig brug.
- Læs brugsanvisningen omhyggeligt, inden installationen af produktet påbegyndes. Forkert installation kan være en farekilde.
- Før installationen påbegyndes skal produktets integritet kontrolleres.
- Installér ikke produktet i eksplosive omgivelser og atmosfærer: tilstedeværelsen af brandfarlig gas eller dampe udgør en alvorlig sikkerhedsrisiko.
- Fare for eksplosion, hvis batteriet er udskiftet med en forkert type.
-  Emballagematerialerne (plast, polystyren osv.) må ikke efterlades i miljøet eller inden for børns rækkevidde, da de udgør en potentiel farekilde.

Bortskaffelse af affald fra elektrisk og elektronisk udstyr

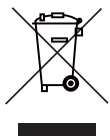

Symbolet med den overkrydsede skraldespand indikerer, at produktet ikke må bortskaffes med almindeligt husholdningsaffald. Produktet skal genanvendes i overensstemmelse med lokale miljøbestemmelser for bortskaffelse af affald. Ved at adskille produkt, der er markeret med dette symbol, fra husholdningsaffaldet, vil det bidrage til at reducere mængden af affald bestemt til forbrændingsanlæg eller lossepladser, hvilket minimerer mulige negative indvirkninger på menneskers sundhed og miljøet. Overhold de gældende forskrifter i dit boligområde, når batteriet skal bortskaffes. Batteriet må ikke bortskaffes som almindeligt husholdningsaffald!



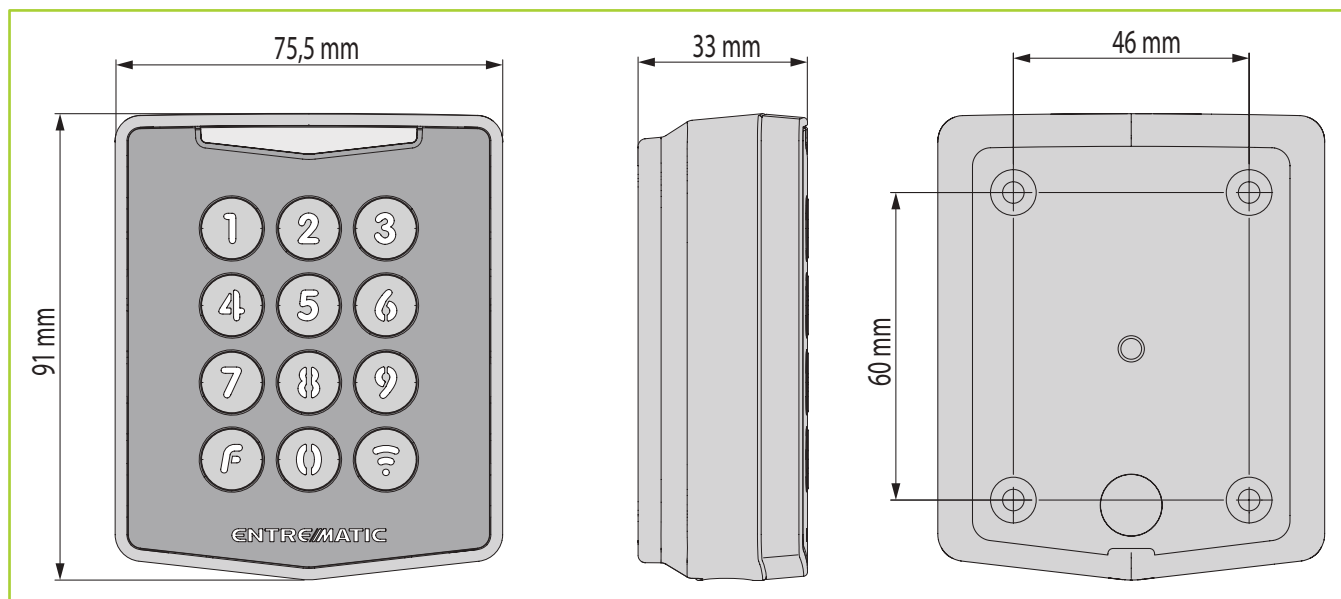

1. Mått

1. Størrelser



2. Tekniska data

2. Tekniske data

	AXK4	AXK4P/PS
Driftsfrekvenser <i>Aktive frekvenser</i>	433,92 MHz	868,35 MHz
Utstrålad effekt <i>Udstrålet effekt</i>	< 1 mW	< 1 mW
Överföringsprotokoll <i>Transmissionsprotokol</i>	Rolling code data frame (kan ändras med AES-128) (kan udskiftes med AES-128)	AES-128 encrypted data frame (kan ändras med Rolling code) (kan udskiftes med Rolling code)
Tillgängliga kanaler <i>Tilgængelige kanaler</i>	Fyra (CH1, CH2, CH3, CH4), aktiverade med fyra olika sifferkoder. <i>Fire (CH1, CH2, CH3, CH4), aktive med fire forskellige numeriske koder</i>	
Avstånd <i>Distance</i>	50 m - 150 m (utomhus, fågelvägen) / (udendørs, fugleflugtlinje)	
Strömförsörjning <i>Forsyning</i>	9 volt alkaline battery, 6LR61	 LITHIUM LITHIUM ION
Extern strömförsörjning [*] <i>Eksterne strømforsyning</i> [*] 	12 - 24 volt DC	
Skyddsgrad <i>Beskyttelsesgrad</i>	IP55	
Temperaturintervall för användning (°C) <i>Driftstemperaturinterval</i> (°C)	 -20°C -  +50°C	
Vikt <i>Vægt</i>	165 g	

Observera! Uttjänta batterier ska läggas i avsedda WEEE-behållare eller lämnas in till avsedda miljöstationer.

Advarsel! Udtømte batterier skal placeres i dedikerede WEEE-beholdere eller på passende indsamlingssteder.

[*] **Varning!** Försäkra dig om att koppla bort det inre batteriet när extern strömförsörjning används.

Extern strömförsörjning får bara användas som **alternativ** till det inre.

[*] **Advarsel!** Sørg for at afbryde det interne batteri, når der bruges ekstern strømforsyning.

Den eksterne strømforsyning bør kun bruges som alternativ til den interne.



3. EU-försäkran om överensstämmelse

3. EU-overensstemmelseserklæringens

Tillverkaren Entrematic Group AB med säte på Lodjursgatan 10, SE-261 44 Landskrona, Sverige, intygar att produkterna AXK4, AXK4P och AXK4PS uppfyller de väsentliga kraven och andra relevanta bestämmelser i direktivet 2014/53/EU RED.

Producenten Entrematic Group AB, hjemmehørende på adressen Lodjursgatan 10, SE-261 44 Landskrona, Sverige, erklærer, at produkterne AXK4, AXK4P og AXK4PS overholder de væsentlige krav og andre relevante bestemmelser i direktiv 2014/53/EU (RED).

Landskrona, 2018-05-02



Matteo Fino

(President Entrematic Itay S.p.A.)

4. Avsedd användning

4. Tilsigtet brug

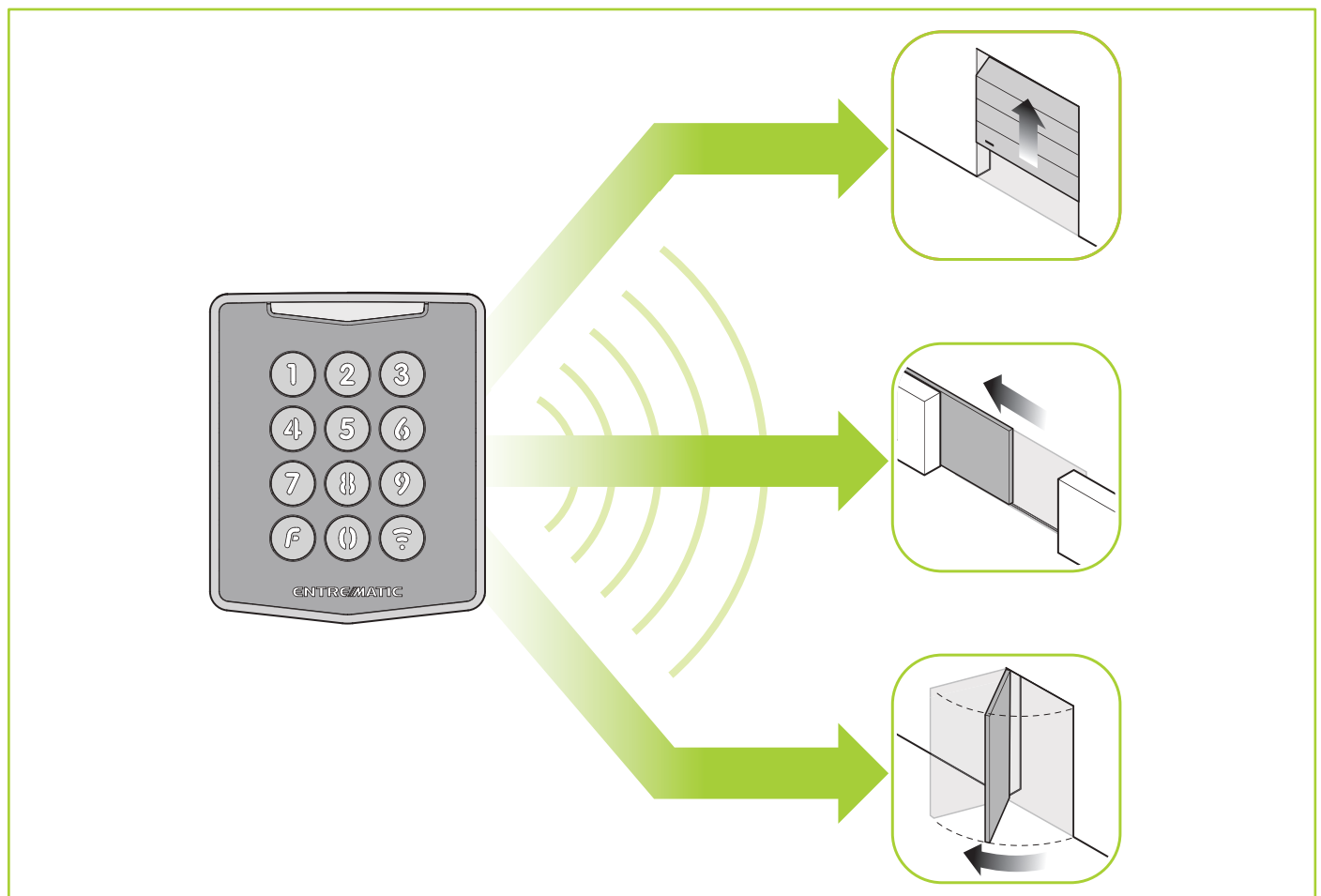

5. Installationsfaser

5. Installationsfaser

STEP 1

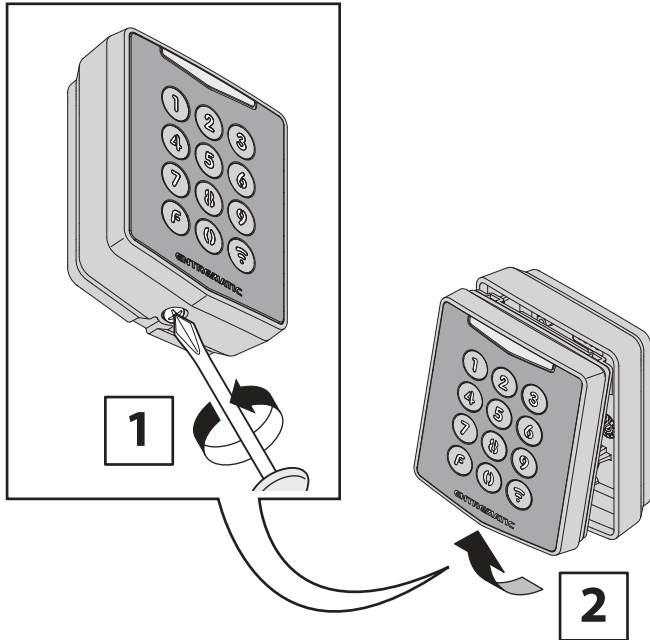

STEP 2

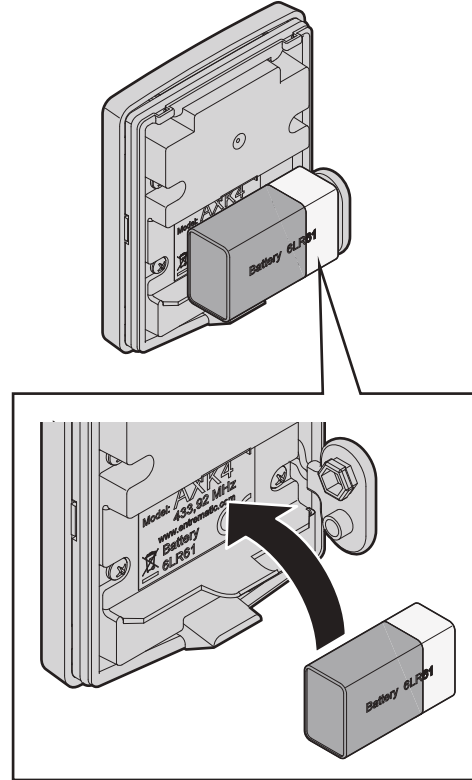

STEP 3

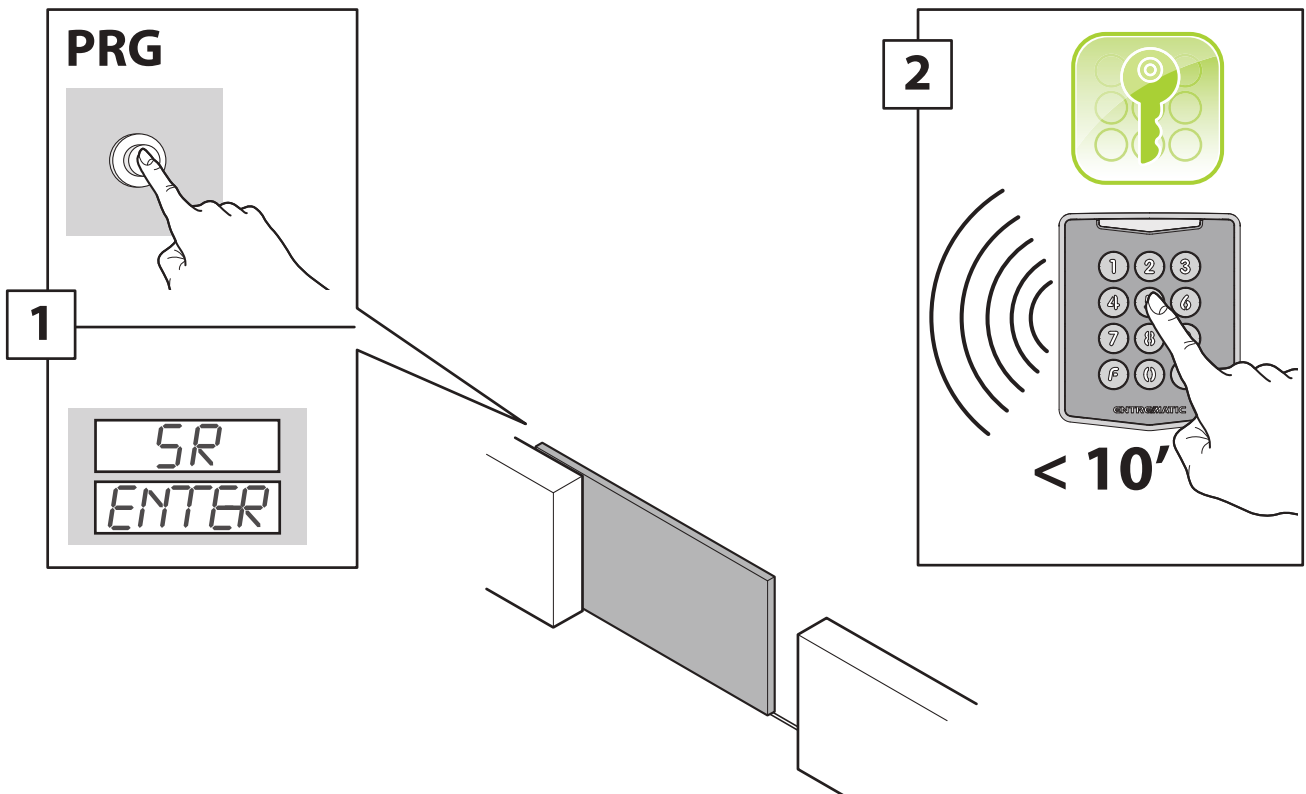

STEP 4

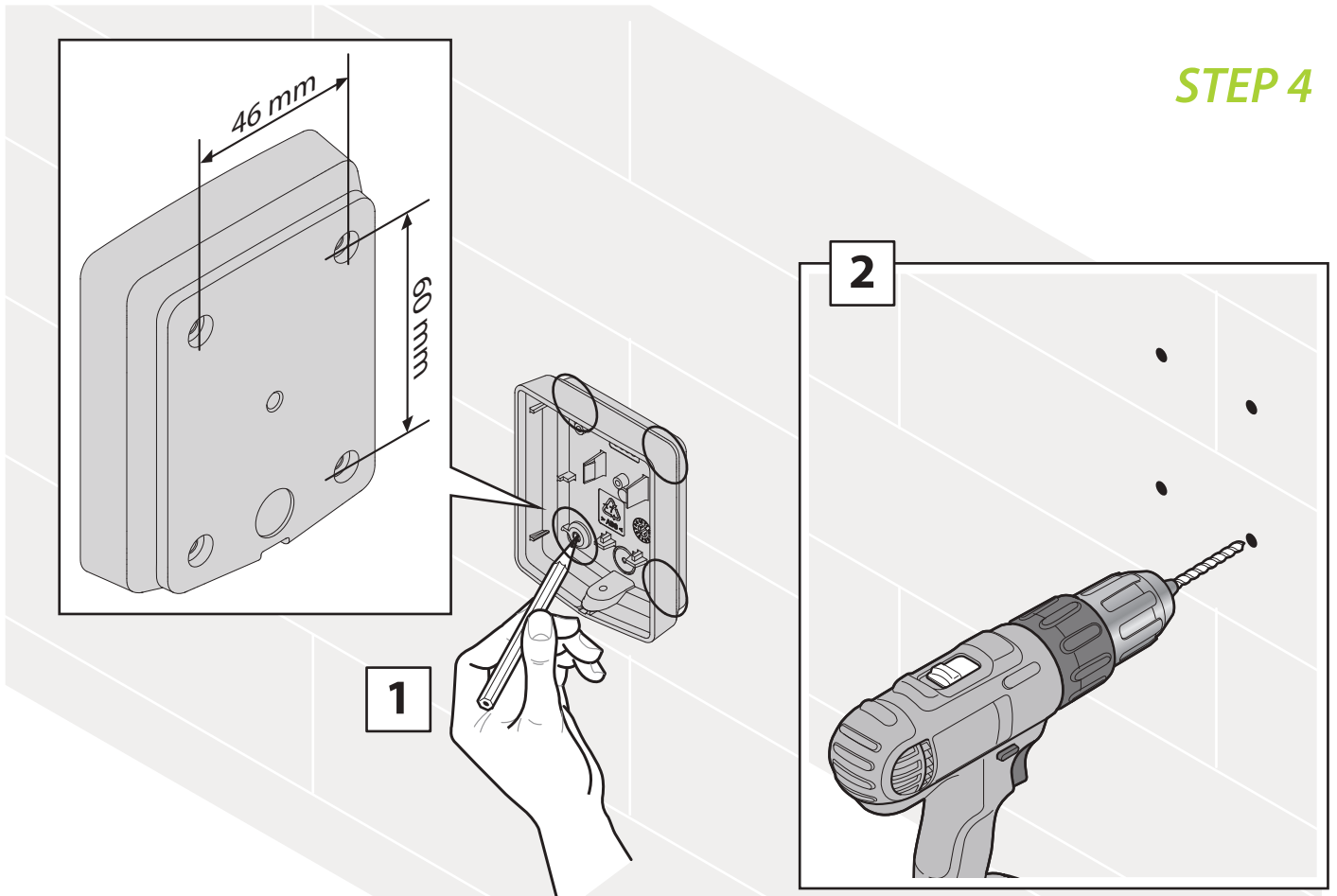

STEP 5

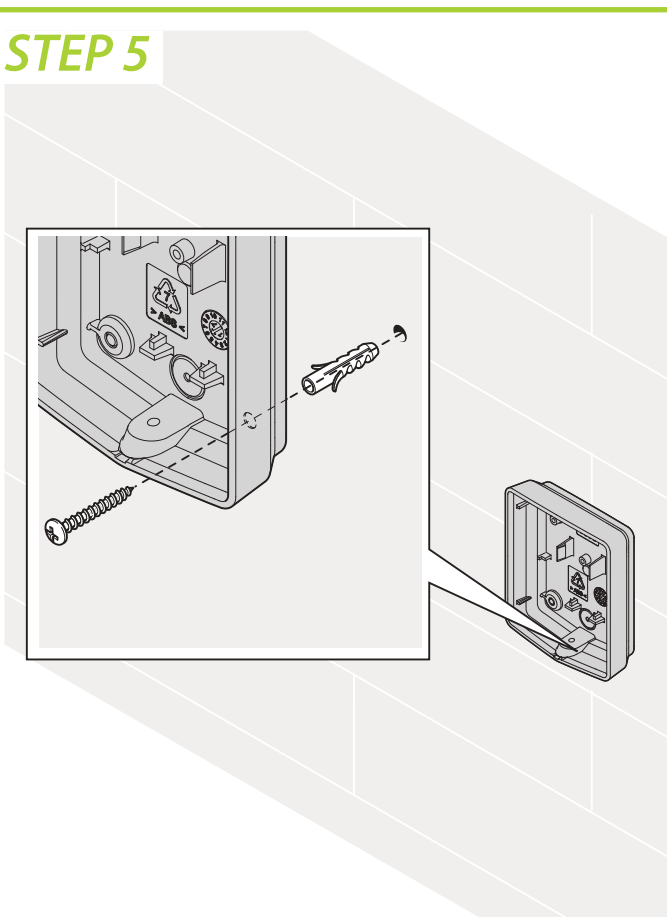

STEP 5A



Bara för extern strömförsörjning.
Kun for den eksterne strømforsyning.

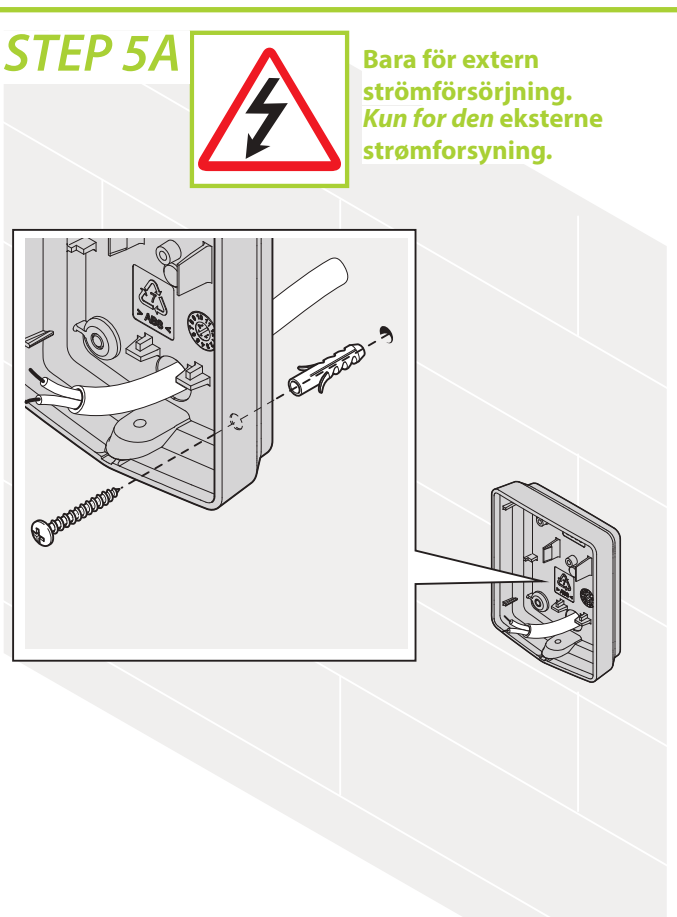

STEP 6



Bara för extern strömförsörjning.
Kun for den eksterne strømforsyning.

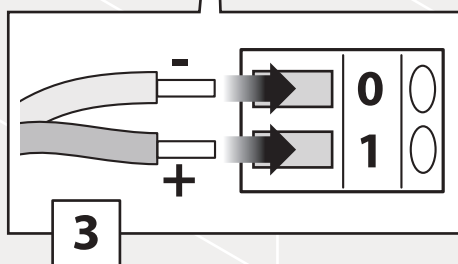
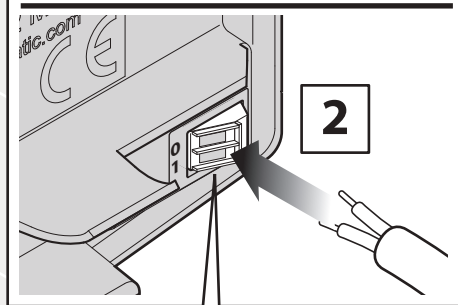
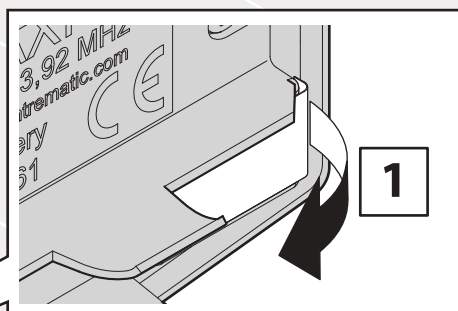
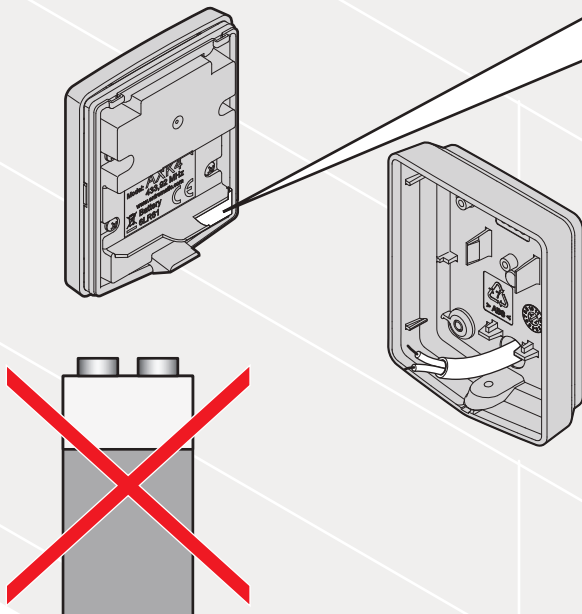

STEP 7

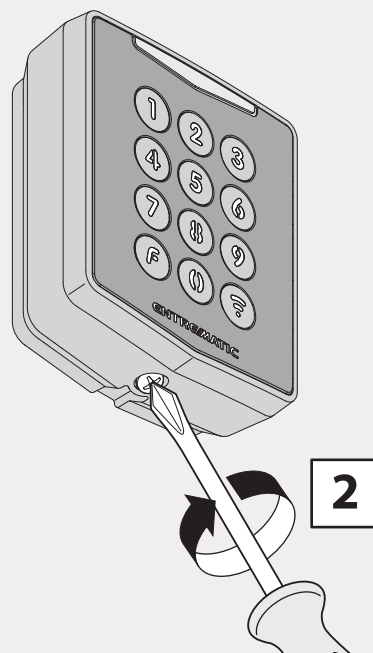
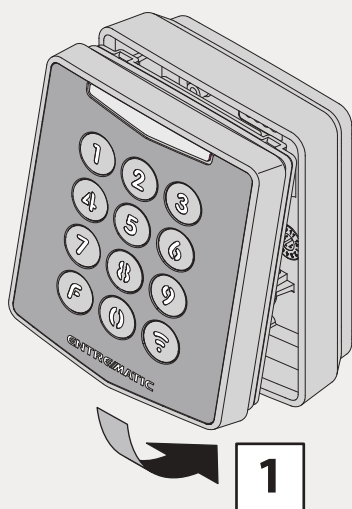

6. Byte av batteri

6. Udskiftning af batteriet

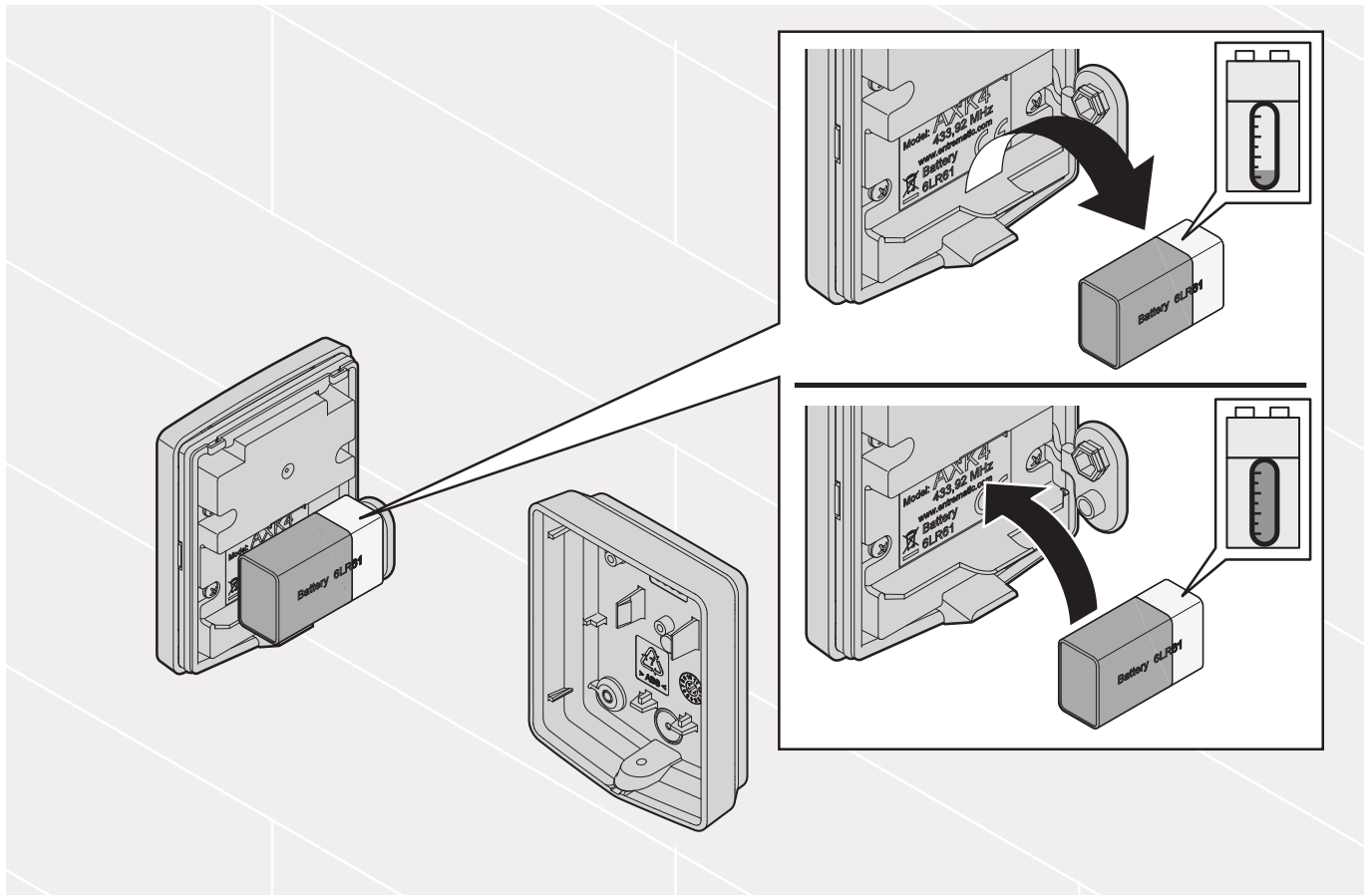

7. Beskrivning av ikoner

7. Beskrivelse af ikonerne



Fabriksinställningar
Fabriksindstillinger



Konfigurationskod
Konfigurationskode



Låsa upp utrustningen
Oplåsning af apparatur



Låsa utrustningen
Låsning af apparatur



Tidsförlopp
Tidsinterval



Kod
Kode



Grönt fast ljus
Grønt lys tændt



Grönt blinkande ljus
Grønt lys blinker



Rött fast ljus
Rødt lys tændt



Rött blinkande ljus
Rødt lys blinker

CH

Kanal (1, 2, 3, 4)
Kanaler (1, 2, 3, 4)



Vilken knapp som helst, förutom
Vilkårlig tast, undtagen



Bara kvalificerad personal
Kun kvalificeret personale



Fel kod
Forkert kode

8. Fabrikskod

8. Fabrikskoder

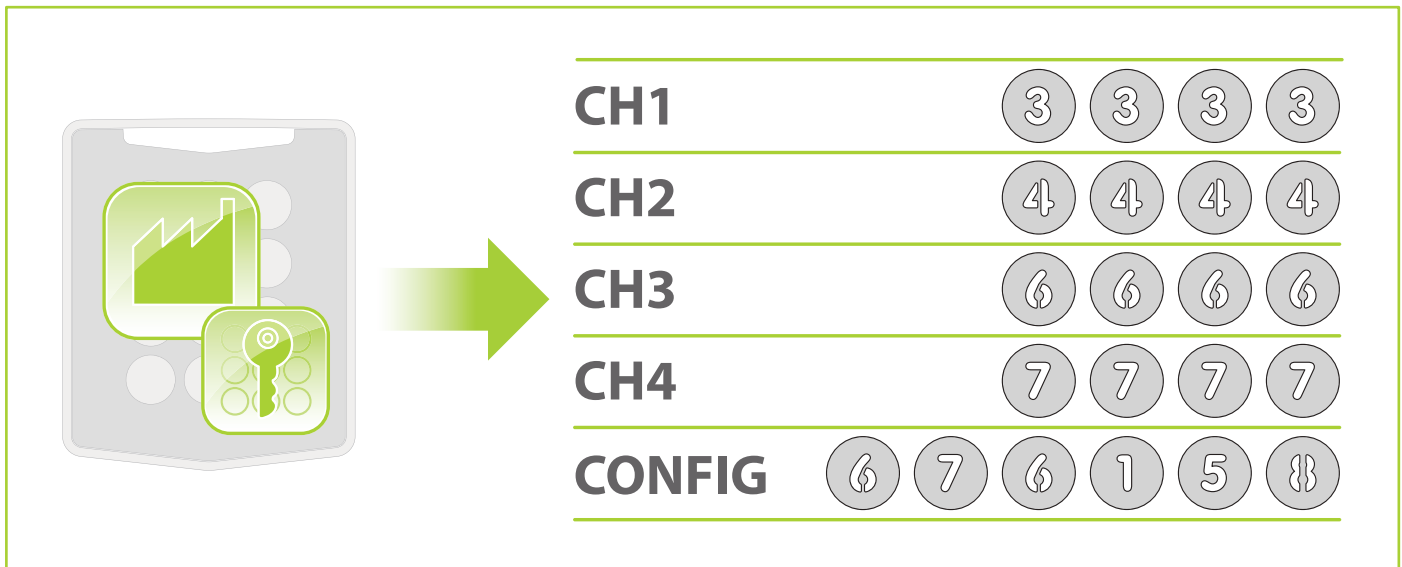

9. Grundläggande styrsekvenser

9. Basis-styrsekvenser

- Aktivera CHn
- Aktivér CHn

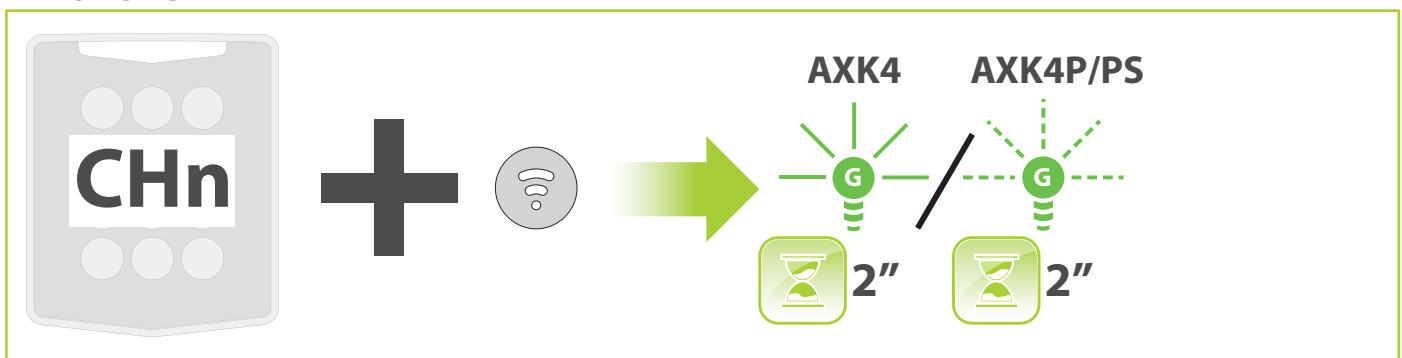

- Aktivera FRI kanal (om konfigurerad)
- Aktivér ÅBEN kanal (hvis konfigureret)

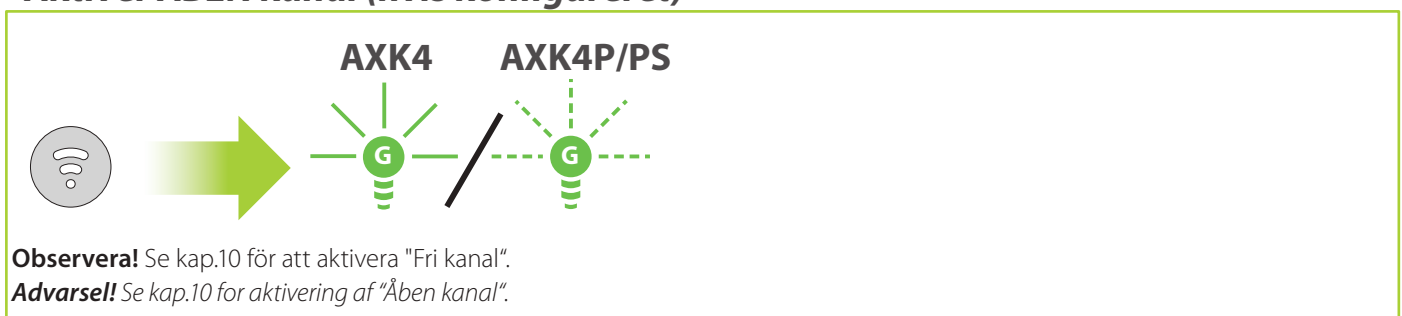

- Upprepa senaste kommandot (inom 10 sek)
- *Gentag den sidste kommando (inden 10 sek.)*

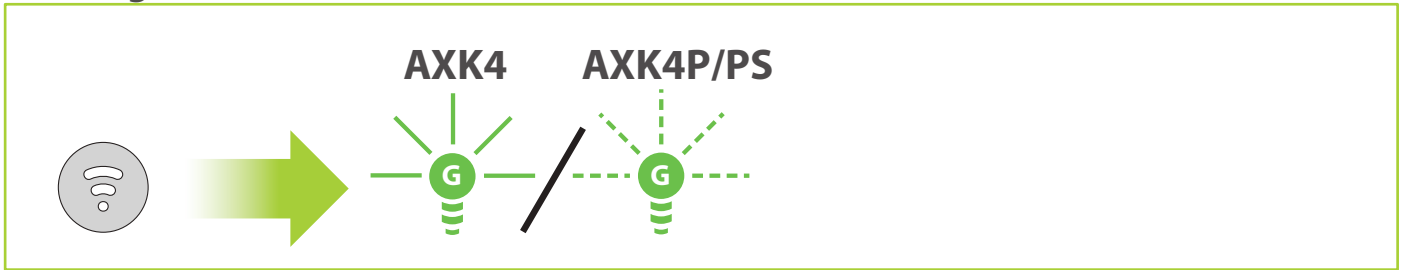

- Aktivera bakgrundsbelysning
- *Aktivér baggrundsbelysning*

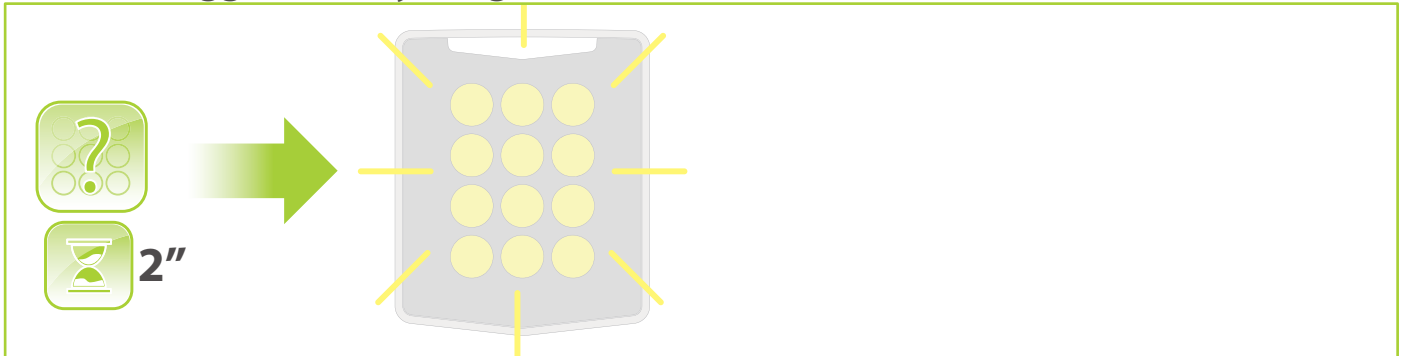

- Radera sekvensen som just skrivits
- *Slet den sidste indtastede sekvens*
- Lämna läget "Upprepa senaste kommandot"
- *Forlad funktionen "Gentag sidste kommando"*

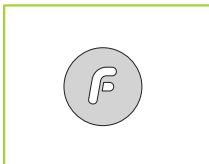

- Identifiering modell
- *Identifikation af modellen*

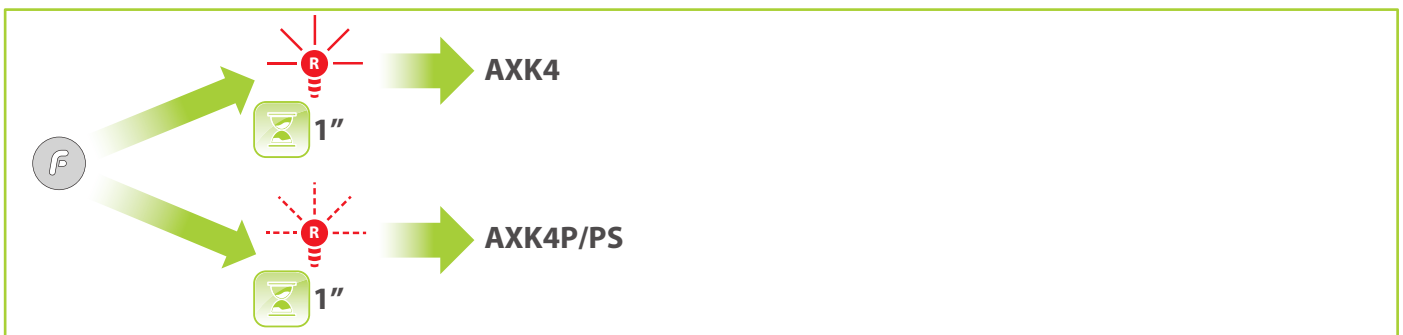

- En kod har skrivits fel
- *Forkert indtastet kode*

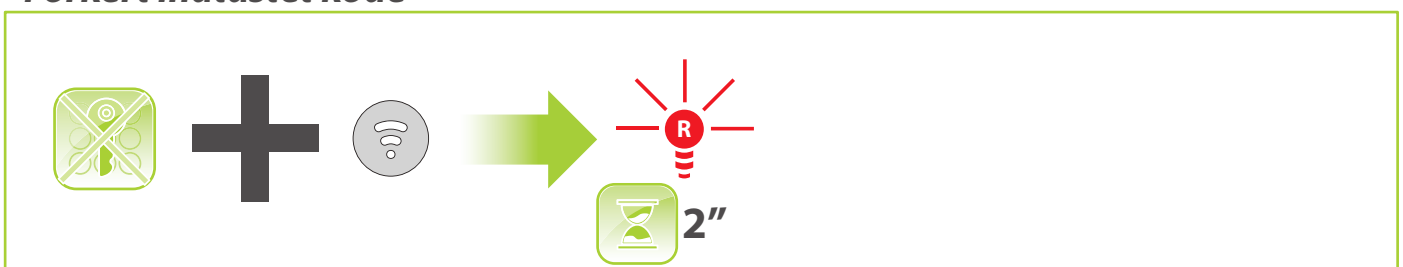

- Upprepad inmatning av fel kod
- Forkert indtastning af kode gentaget



- Eventuella ofullbordade knappsekvenser ignoreras efter 10 sekunders inaktivitet och produkten går tillbaka till standby-läge.
- Pausen mellan ett knapptryck och nästa ska vara mindre än 5 sek.
- *Enhver ufuldstændig TAIS-frekvens ignoreres efter 10 sek. inaktivitet, hvorefter standbytilstand genoprettes.*
- *Pausen mellem at hvert tryk på en tast og den næste skal være mindre end 5 sek.*

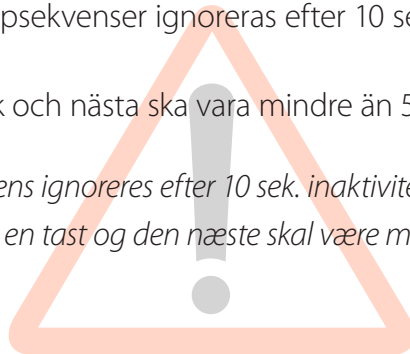

10. Sekvens för kodbyte

10. Sekvens til ændring af koder

- Ändra gammal kod till en ny
- Udskift en gammel kode med en ny

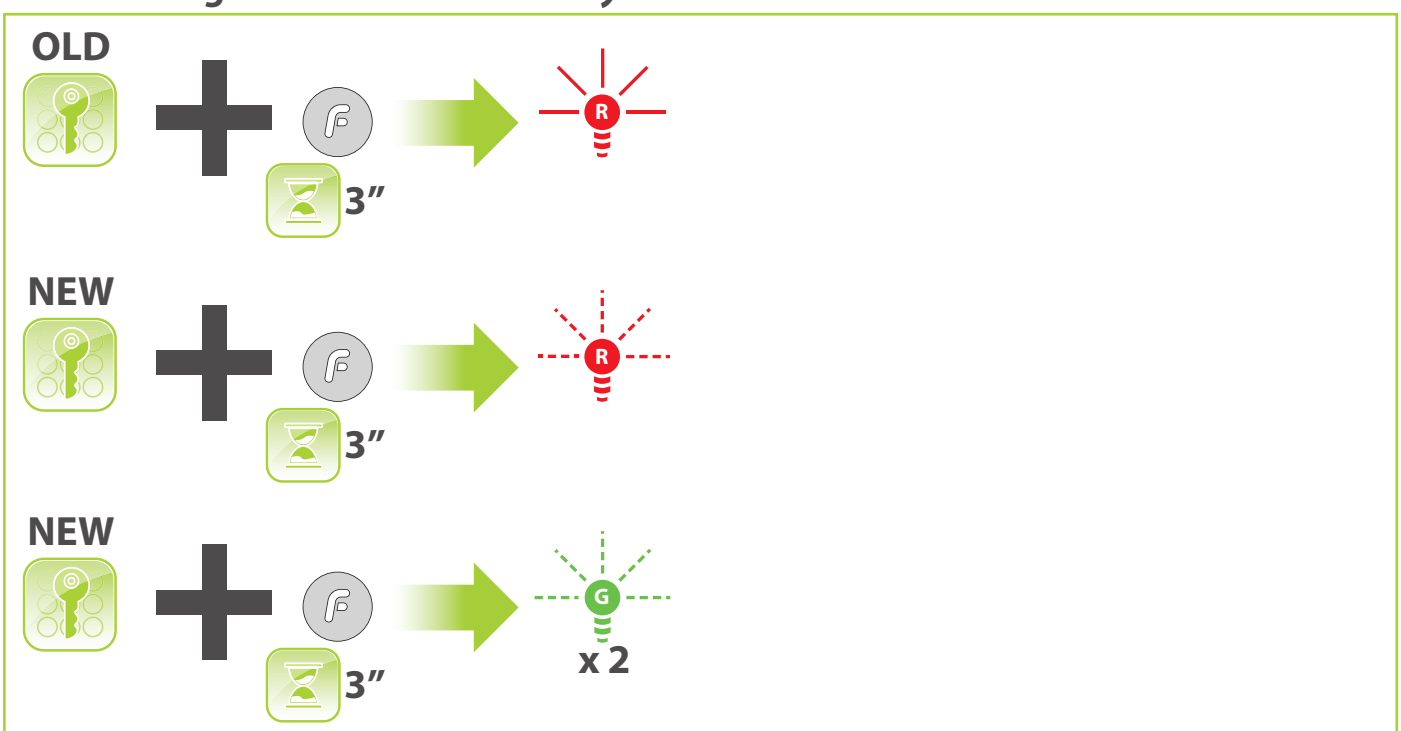

- Konfiguration av en kod med "längd noll" (FRI kanal)

- Konfiguration af en kode med "længden nul" (ÅBEN kanal)

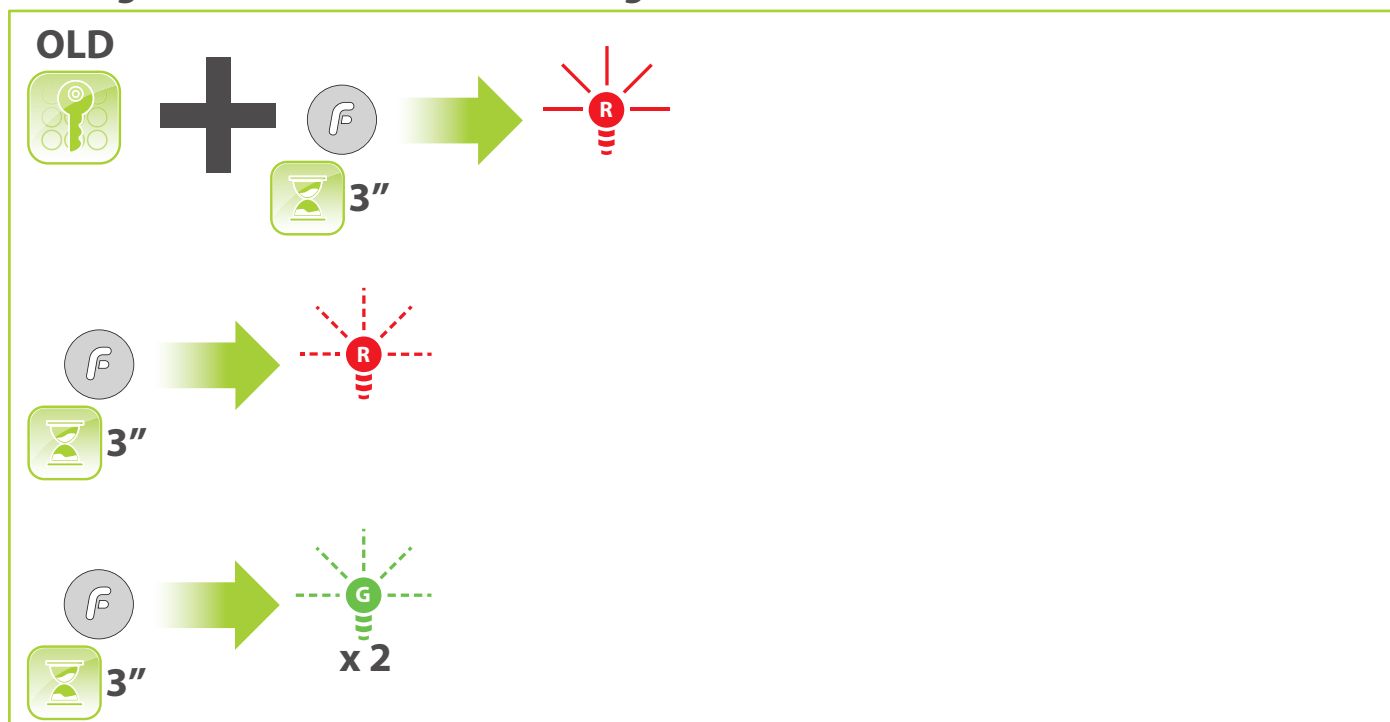

- Användarkoderna ska ha en längd mellan 0 (FRI kanal) och 8 siffror.
- En enda kanal kan konfigureras som "FRI kanal".
- Följaktligen kan inte fabrikskoderna användas för att aktivera andra koder än de fördefinierade (till exempel, koden "3333" kan inte användas på CH4).
- En ofullbordad sekvens för byte av kod ignoreras efter 10 sekunders inaktivitet och produkten går tillbaka till standby-läge.
- En felaktig sekvens för byte av kod medför att den RÖDA LYSDIODEN tänds i 3 sek och sedan går produkten tillbaka till standby-läge.

- *Brugerens koder skal have en længde på mellem 0 (ÅBEN kanal) og 8 cifre.*
- *Det er kun muligt at konfigurere en enkelt kanal som "ÅBEN kanal".*
- *Som følge heraf kan fabrikskoder ikke bruges til at aktivere andre kanaler end standardkanalerne (for eksempel kan kode "3333" ikke bruges på CH4).*
- *Enhver ufuldstændig ændring af en kode ignoreres efter 10 sek. inaktivitet, hvorefter standbytilstand genoprettes.*
- *Ved forkert sekvens for ændring af kode tænder den RØDE LED i 3 sek., hvorefter produktet genopretter standbytilstanden.*

11. Status CONFIG

11. Tilstanden CONFIG



- Ändra gammal kod CONFIG till en ny
- Udsift en gammel CONFIG-kode med en ny

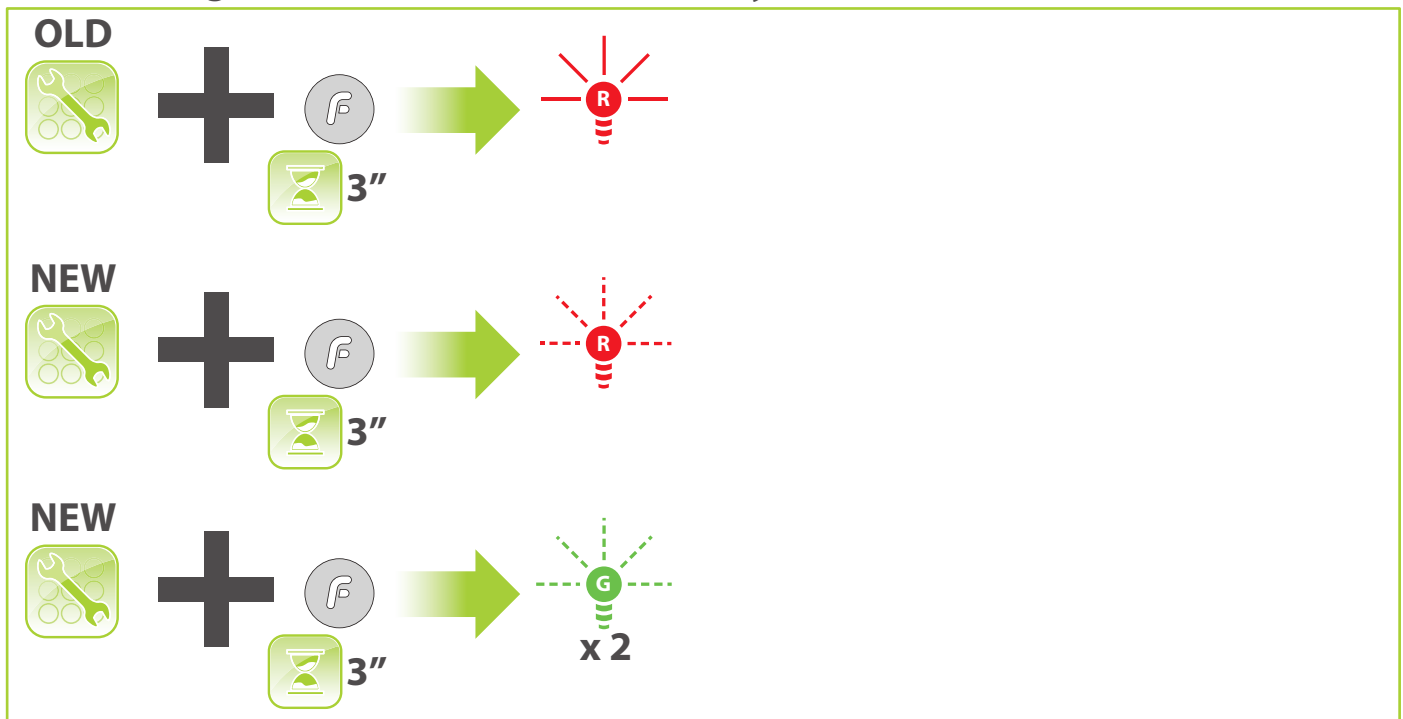

- Åtkomst till läget CONFIG
- Adgang til funktionen CONFIG

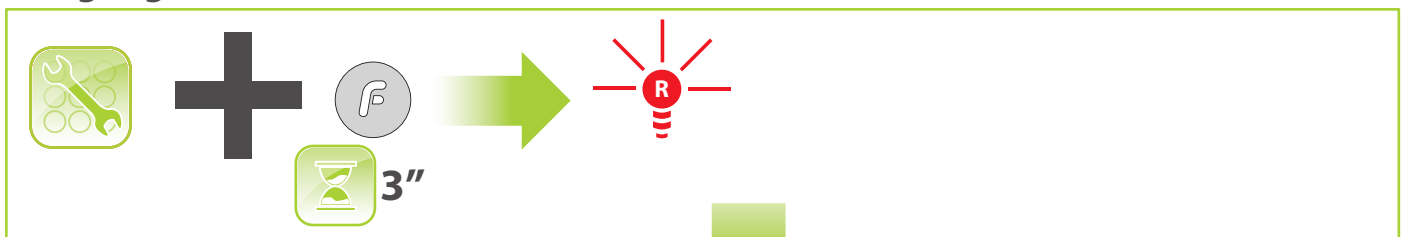

- Återställ FRI kanal till standard
- Nulstilling af ÅBEN kanal til fabriksindstilling

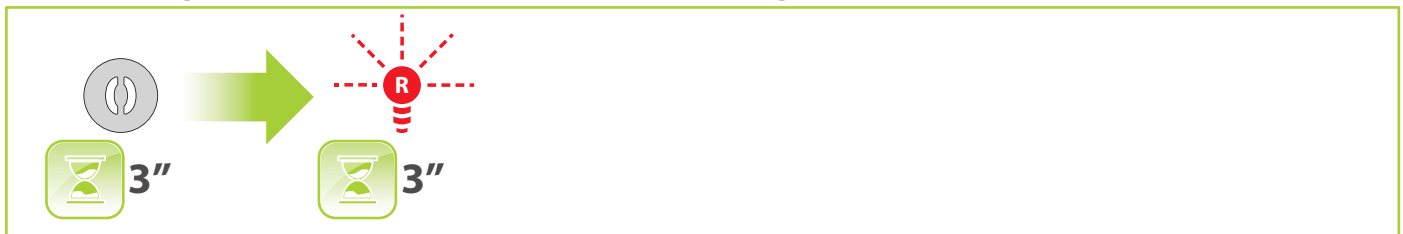

- Omkoppla ROLL / ENC på CH1-CH2
- Kommutation ROLL / ENC for CH1-CH2

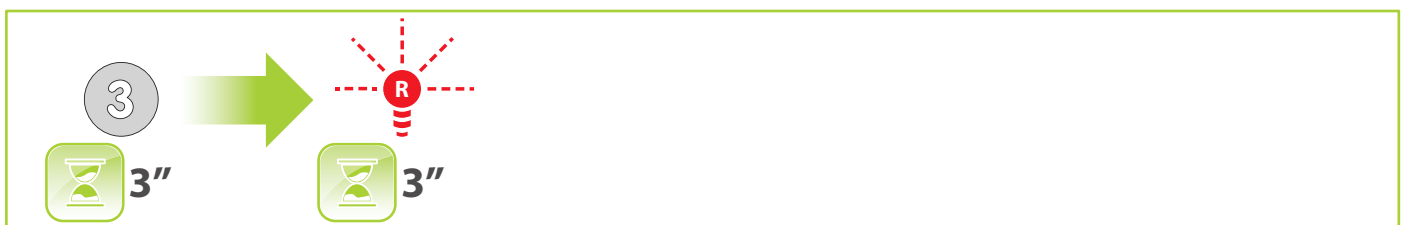



- Omkoppla ROLL / ENC på CH3-CH4
- *Kommutation ROLL / ENC for CH3-CH4*

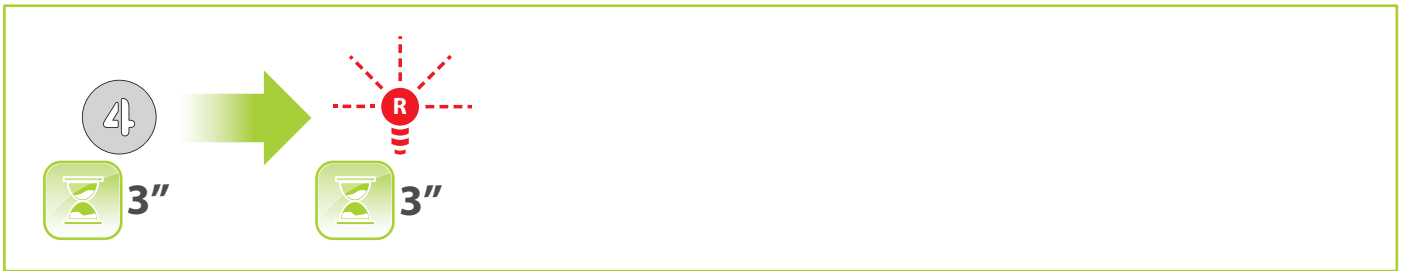

- **AKTIVERA** funktionen byte av koder
- *AKTIVÉR kodeændringsfunktion*

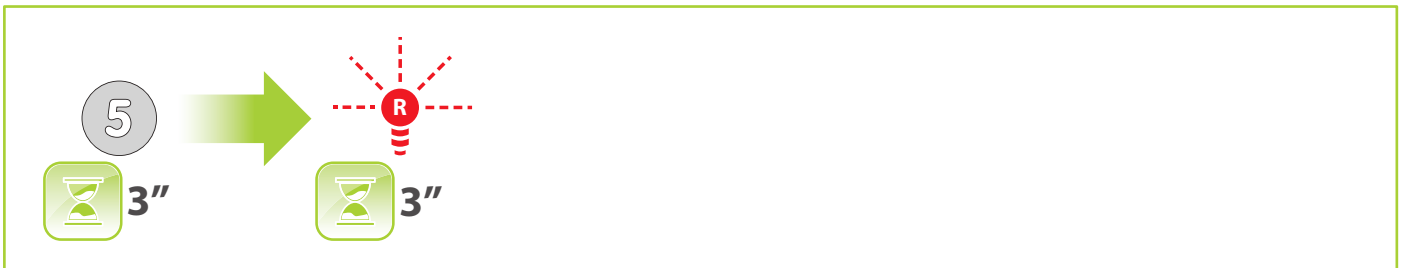

- **AVAKTIVERA** funktionen byte av koder
- *DEAKTIVÉR kodeændringsfunktion*

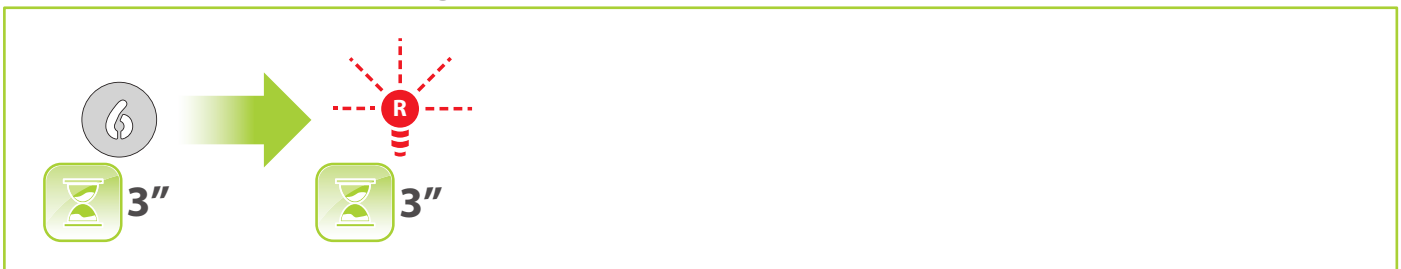

- **ÅTERSTÄLL** till fabriksinställningar
- *GENOPRET fabrikskonfiguration*

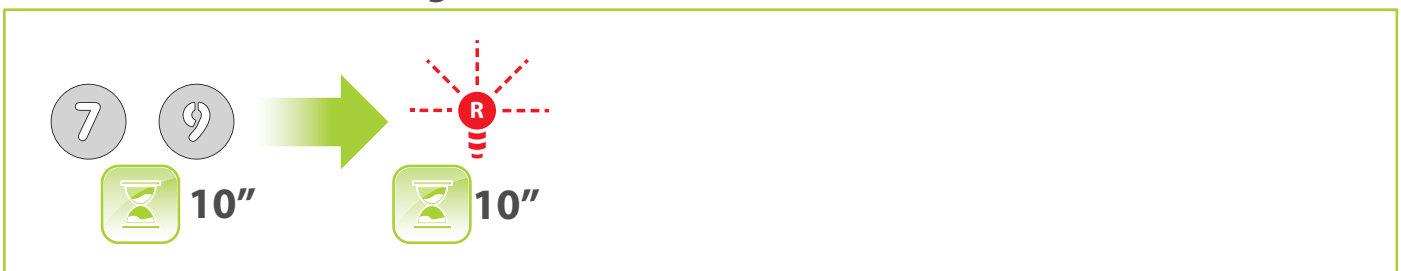

- **Total BLOCKERING** av konfigurationen
- *Konfiguration LÅST*





- Konfigurationskoden (CONFIG) ska ha en längd från 4 till 8 siffror.
- När konfigurationsläget har aktiverats har man 30 sek på sig för att utföra önskad åtgärd. Om denna tid överskrids utan att ha slutfört den pågående åtgärden går produkten tillbaka till standby-läget utan att göra någon ändring på produkten.
- Efter att ha aktiverat total BLOCKERING av konfigurationen går det inte längre att göra någon ändring på konfigurationen eller FABRIKSÅTERSTÄLLNING.
- *Konfigurationskoden (CONFIG) skal have en længde på mellem 4 og 8 cifre.*
- *Når konfigurationstilstanden er åbnet, er tiden til rådighed til at udføre den ønskede operation 30 sek. Hvis denne tid overskrides uden at den igangværende operation afsluttes, genopretter produktet standbytilstand uden at gemme nogen ændringer for produktet.*
- *Når konfigurationen er LÅST, så er det ikke muligt at udføre nogen ændringer ved konfigurationen eller GENOPRETTE fabriksindstillingerne.*



Entromatic Group AB
Lodjursgatan 10
SE-261 44, Landskrona
Sweden
www.entromatic.com



ENTRE//MATIC

AXK4 Series



IP2292 - 018/06/08

Generelle sikkerhetsadvarsler

- Ta vare på disse instruksene for referanse i framtiden.
- Installasjonen, de elektriske kodingene og justeringene må utføres av kvalifisert personell, i overensstemmelse med god teknikk og alle gjeldende normer må overholdes.
- Dette produktet må kun benyttes til den bruk som det er uttrykkelig beregnet for. All annen bruk må betraktes som uegnet og er dermed farlig. Produsenten kan ikke stilles til ansvar for eventuelle skader som skyldes ukorrekt, feilaktig eller fornuftig bruk.
- Les nøye igjennom instruksene før du begynner å installere produktet. Feil installasjon kan være årsaken til at farlige situasjoner oppstår.
- Før du begynner installasjonen må du påse at produktet er helt.
- Produktet må ikke installeres i eksplosive omgivelser eller atmosfærer: tilstedeværelse av brannfarlig gass eller røyk er en alvorlig fare for sikkerheten.
- Fare for eksplosjon hvis batteriet er erstattet med feil type.
-  Emballasjematerialet (plast, polystyren, osv.) må ikke hives ut i naturen og de må ikke etterlates slik at de ligger tilgjengelig for barn som potensielle farekilder.

Avfallsbehandling av elektrisk/elektronisk utstyr

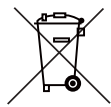

Symbolet viser en søppeldunk med et kryss over. Dette betyr at produktet ikke skal kastes i søpla, men holdes atskilt fra husholdningsavfallet. Produktet skal leveres til resirkulering i henhold til lokale ordninger for kildesortering. Ved å holde produktet atskilt fra ordinært husholdningsavfall, hjelper du til med å redusere mengden avfall som går til gjenvinningsanlegg eller søppelplasser og med å unngå potensiell negativ virkning på menneskers helse og miljøet.

Når det gjelder avfallsbehandling av batteriet, må du følge normene som gjelder i området der du bor. Batteriet kan ikke kastes sammen med husholdningsavfall!

Yleiset turvallisuutta koskevat varoitukset

- Säilytä nämä ohjeet tulevaa tarvetta varten.
- Asennus, sähköliitännät ja säädöt on suoritettava ammattitaitoisen henkilökunnan toimesta hyvien teknisten käytäntöjen ja voimassa olevien määräysten.
- Tätä tuotetta saa käyttää ainoastaan käyttötarkoitukseen, jota varten se on nimenomaisesti suunniteltu. Kaikki muu käyttö katsotaan sopimattomaksi ja siten vaaralliseksi. Valmistajaa ei voida pitää vastuullisena mahdollisista vahingoista, jotka aiheutuvat sopimattomasta, virheellisestä tai kohtuuttomasta käytöstä.
- Lue huolellisesti ohjeet ennen laitteen asennuksen aloittamista. Virheellinen asennus voi olla syynä vaaratilanteelle.
- Ennen asennuksen aloittamista tarkasta tuotteen ehjyys.
- Älä asenna tuotetta räjähdysvaarallisiin ympäristöihin ja tiloihin: syttyvien kaasujen tai savujen läsnäolo aiheuttaa vakavan vaaran turvallisuudelle.
- Räjähdysvaara, jos akku vaihdetaan vääryntyyppiseen.
-  Pakkausmateriaaleja (muovi, polystyreeni ym.) ei saa heittää ympäristöön eikä niitä saa jättää lasten ulottuviin, koska ne voivat aiheuttaa vaaratilanteita.

Sähkö-/elektroniikkaromun hävittäminen



Rastitettu roskakoritunnus osoittaa, että tuotetta ei saa hävittää tavallisen yhdyskuntajätteen joukossa. Tuote on kierrätettävä noudattaen paikallisia jätteiden hävittämistä koskevia määräyksiä. Erottamalla kyseisellä tunnuksella varustettu tuote kotitalousjätteistä, autetaan vähentämään polttolaitoksiin tai kaatopaikalle päätyvien jätteiden määrää ja siten voidaan minimoida mahdolliset ihmisille ja ympäristölle aiheutuvat negatiiviset vaikutukset.

Paristo on hävitettävä paikallisten määräysten mukaisesti. Paristoa ei saa hävittää kotitalousjätteiden mukana!



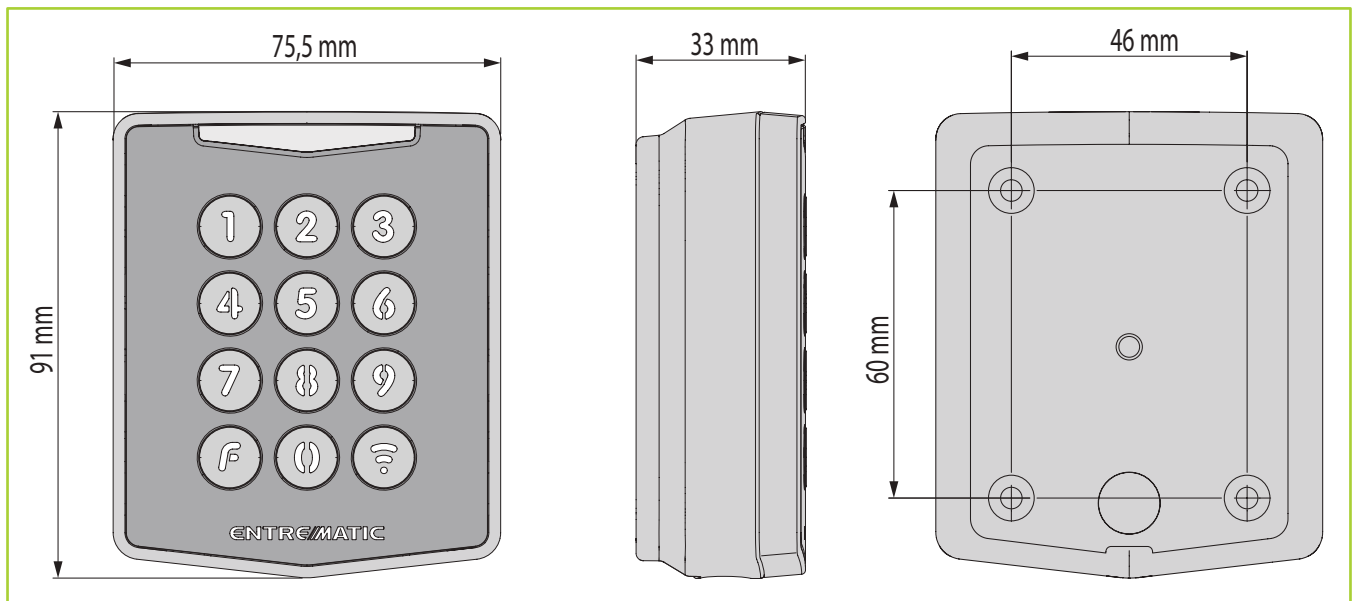

1. Dimensjoner

1. Mitat



2. Tekniske data

2. Tekniset tiedot

	AXK4	AXK4P/PS
Driftsfrekvens <i>Työtaajuudet</i>	433,92 MHz	868,35 MHz
Utstrålt effekt <i>Säteilyteho</i>	< 1 mW	< 1 mW
Overføringsprotokoll <i>Lähetysprotokolla</i>	Rolling code data frame (kan byttes med AES-128) <i>(voidaan vaihtaa tilalle AES-128)</i>	AES-128 encrypted data frame (kan byttes med Rolling code) <i>(voidaan vaihtaa tilalle vaihtuvakoodinen)</i>
Tilgjengelige kanaler <i>Saatavilla olevat kanavat</i>	Fire (CH1, CH2, CH3, CH4), aktiverte med fire forskjellige numeriske koder. <i>Neljä (CH1, CH2, CH3, CH4), aktivoitu neljällä eri numerokoodilla.</i>	
Distanse <i>Etäisyys</i>	50 m - 150 m (ekstern, i luftlinje) / <i>(ulkona, linnuntietä)</i>	
Forsyning <i>Syöttö</i>	9 volt alkaline battery, 6LR61	 LITHIUM LITHIUM ION
Ekstern forsyning [*] <i>Ulkoisen syöttö [*]</i>		12 - 24 volt DC
Beskyttelsesgrad <i>Suojausluokka</i>	IP55	
Temperaturintervall for bruk (°C) <i>Käyttölämpötila-alue (°C)</i>	 -20°C -  +50°C	
Vekt <i>Paino</i>	165 g	

Forsiktig! Utladete batterier må avhendes i egne WEEE-beholdere ved avfallsmottakene for elektrisk/elektronisk avfall.
Huomio! Käytetyt akut on hävitettävä käyttämällä sähkö- ja elektroniikkaromun SER keräykseen tarkoitettuja keräyslaitteita tai asianmukaisia keräyspisteitä.

[*] Advarsel! Forsikre deg om at det innvendige batteriet er frakoplet når ekstern forsyning benyttes. Den eksterne forsyningen benyttes kun **som et alternativ** til den innvendige.

[*] Varoitus! Varmista, että sisäinen akku kytketään irti, kun käytetään ulkoista virtälähdettä. Ulkoista virtälähdettä on käytettävä ainoastaan vaihtoehtona sisäiselle.

3. EU-samsvarserklæringen

3. EU-vaatimustenmukaisuusvakuutuksen

Produsenten Entrematic Group AB med hovedadresse i Lodjursgatan 10, SE-261 44 Landskrona, Sweden, erklærer at produktene AXK4, AXK4P og AXK4PS er i overensstemmelse med de grunnleggende kravene og andre relevante bestemmelser i direktivet 2014/53/UE RED.

Valmistaja Entrematic Group AB, kotipaikka osoitteessa Lodjursgatan 10, SE-261 44 Landskrona, Ruotsi, ilmoittaa, että tuotteet AXK4, AXK4P ja AXK4PS täyttävät uusiutuvia energialähteitä koskevan direktiivin 2014/53/EU keskeiset vaatimukset ja muut olennaiset määräykset.

Landskrona, 2018-05-02



Matteo Fino

(President Entrematic Itay S.p.A.)

4. Tiltenkt bruk

4. Käyttötarkoitus

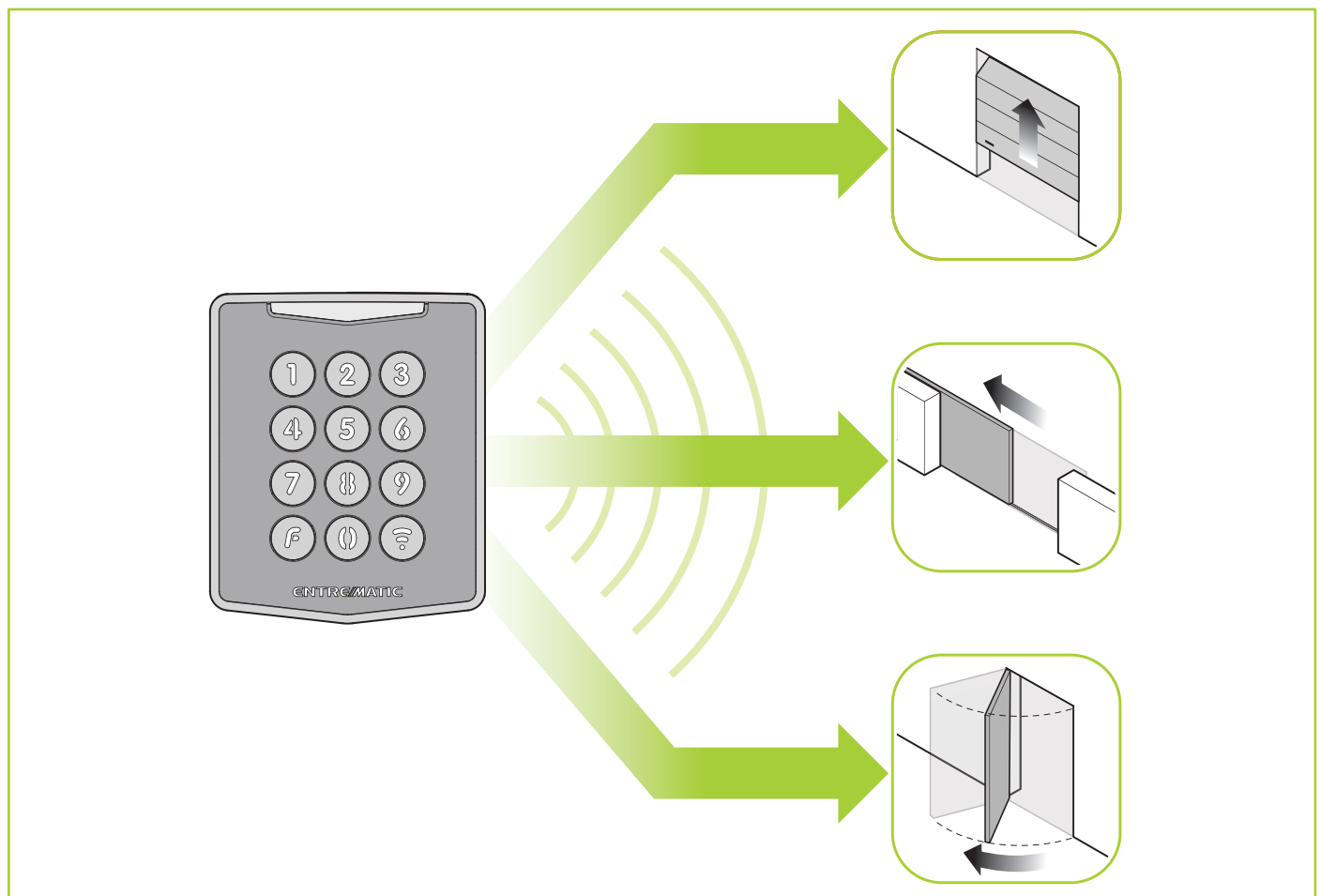

5. Installasjonsfaser

5. Asennusvaiheet

STEP 1

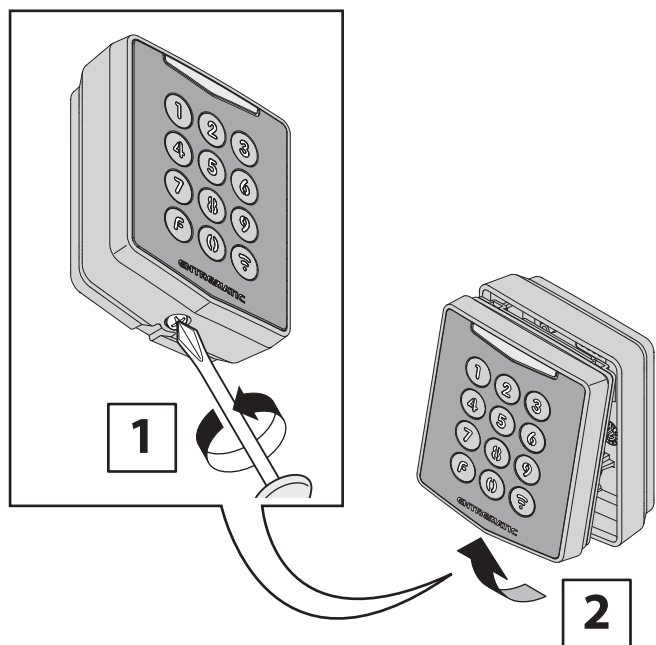

STEP 2

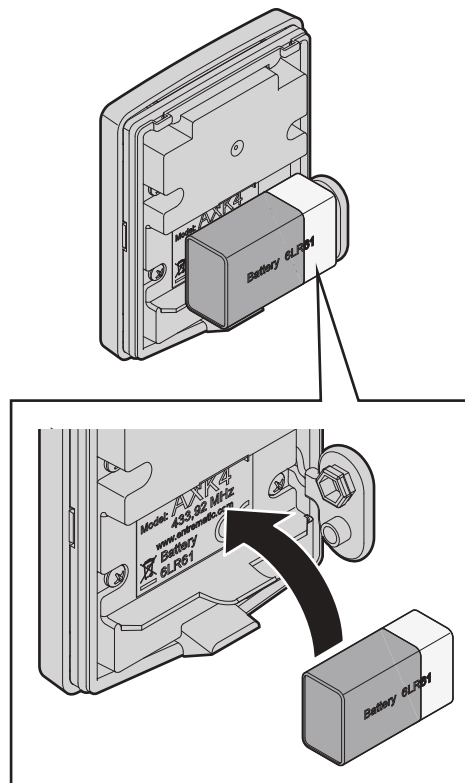

STEP 3

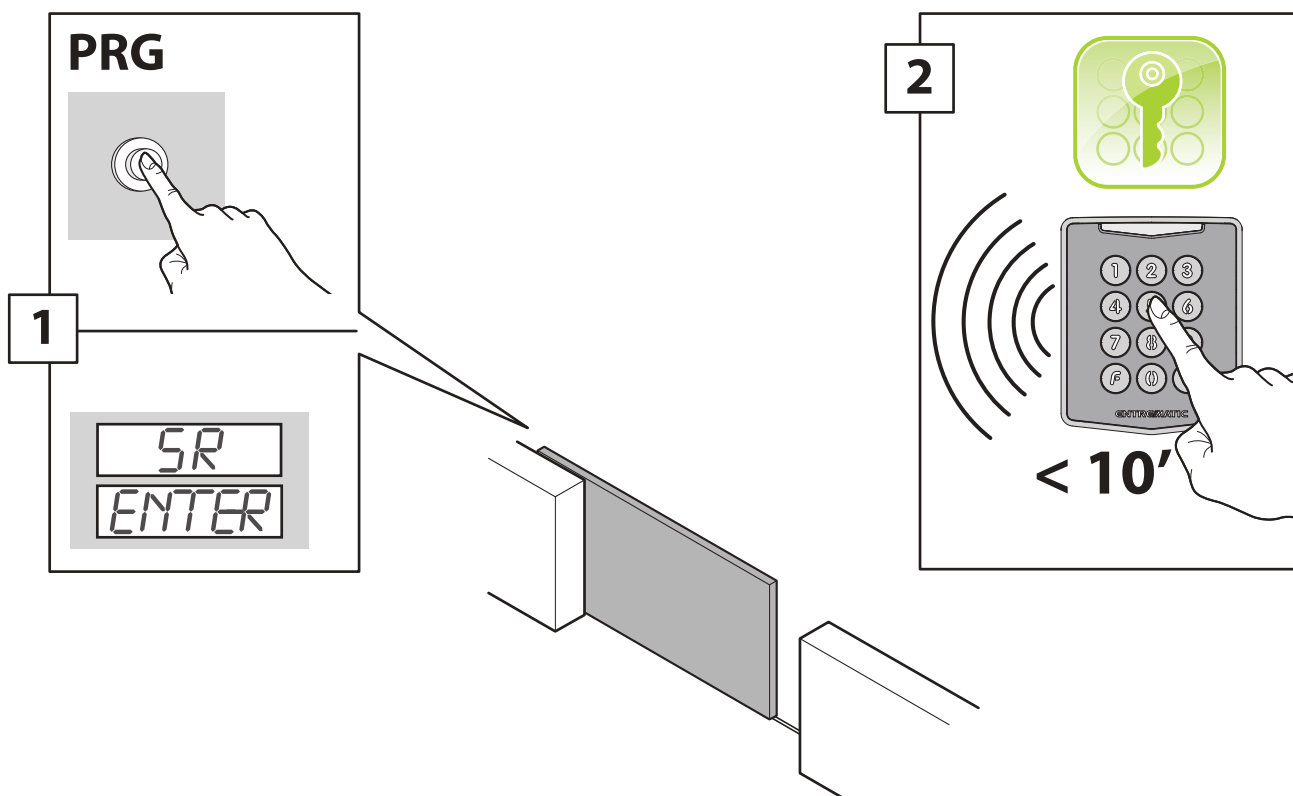

STEP 4

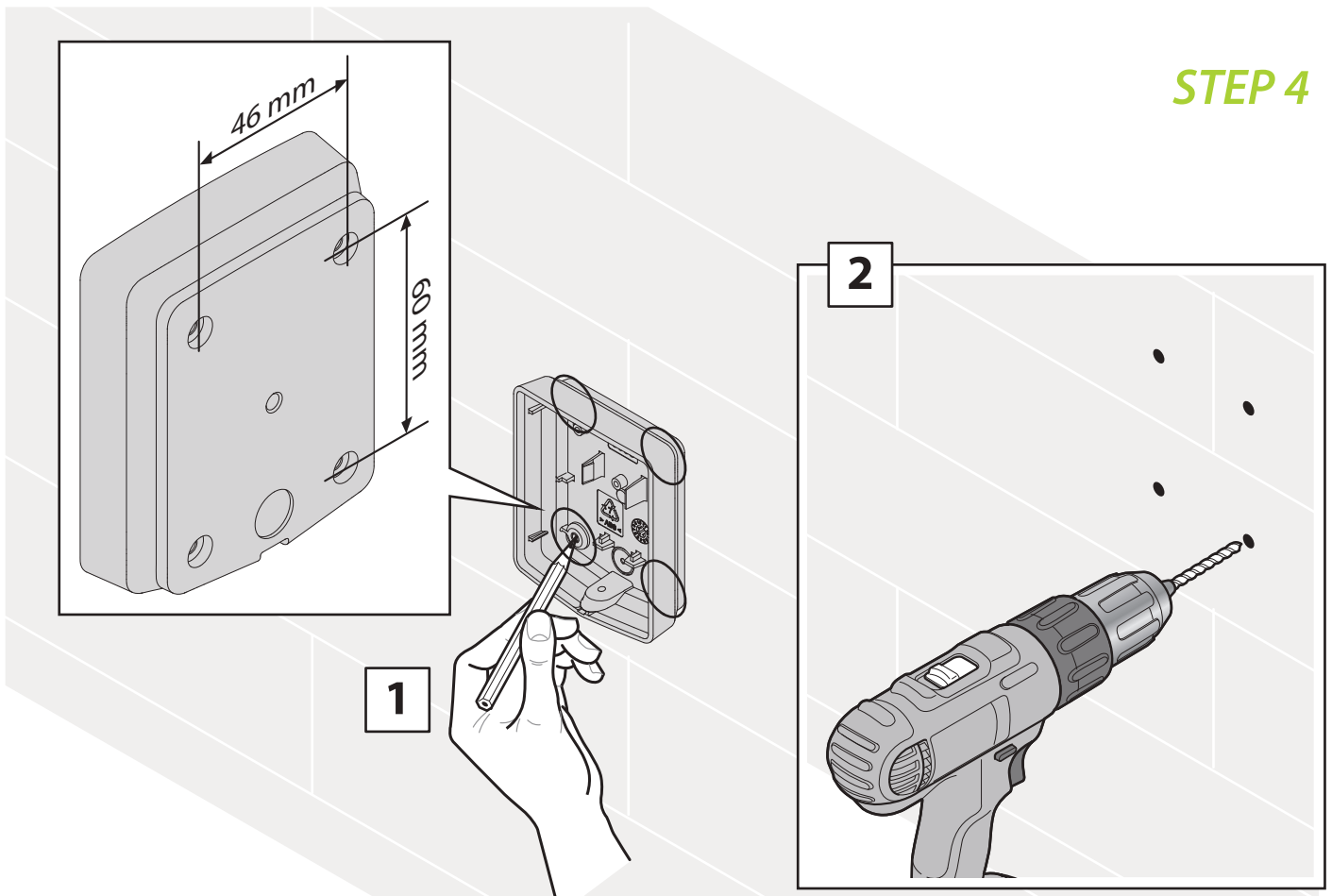

STEP 5

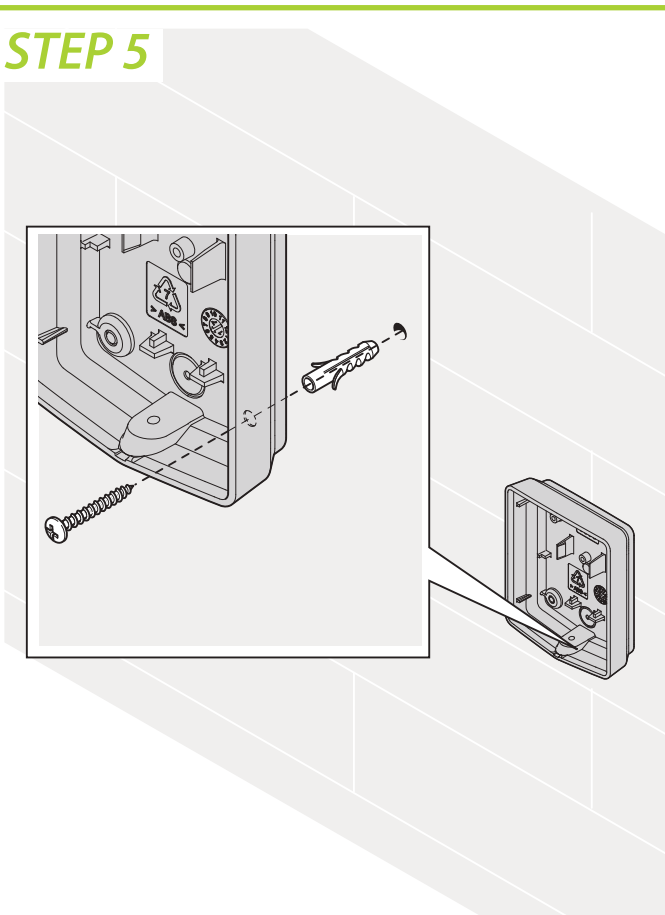

STEP 5A



Kun for utvendig forsyning.
Vain ulkoista virransyöttöä varten.

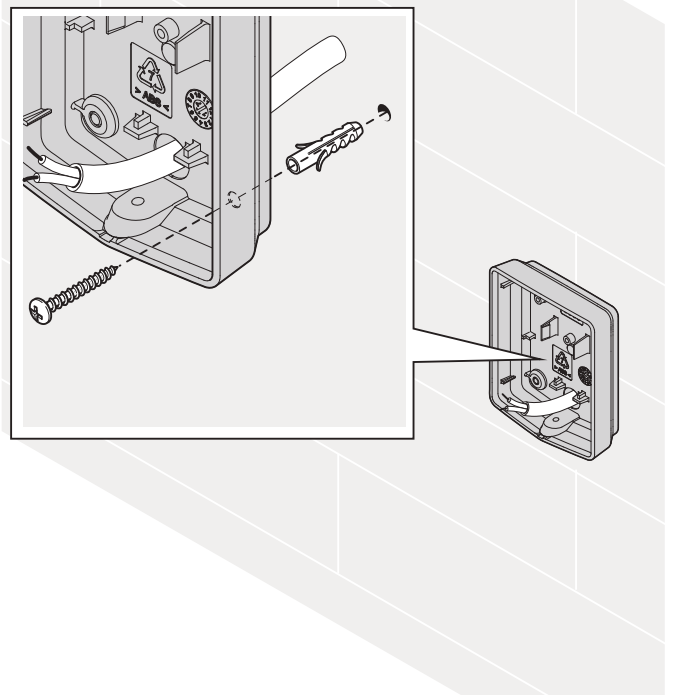

STEP 6



Kun for utvendig
forsyning.
Vain ulkoista
virransyöttöä varten.

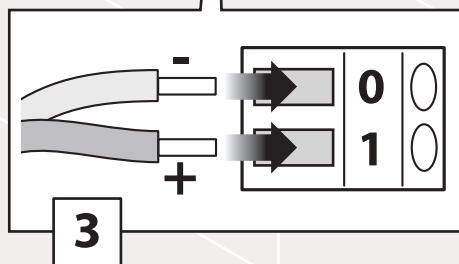
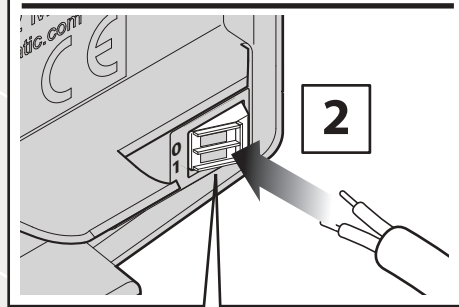
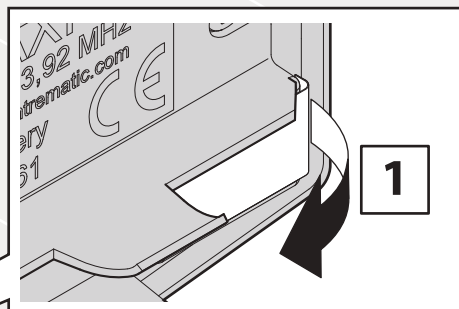
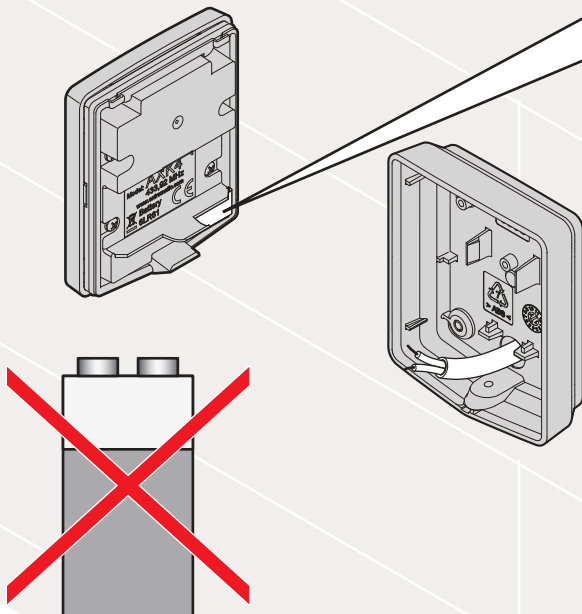

STEP 7

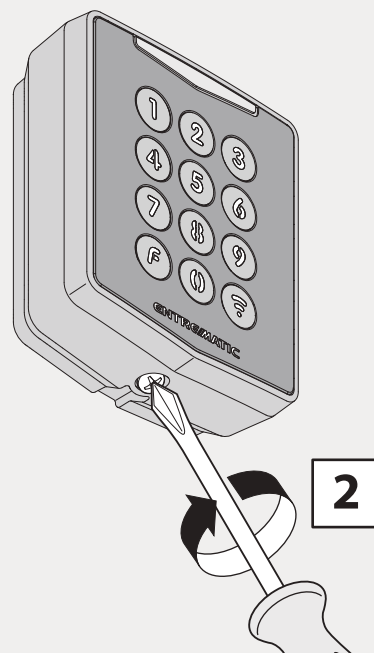
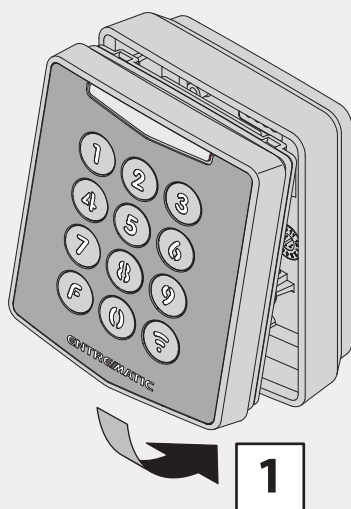

6. Utskiifting av batteri

6. Akun vaihto

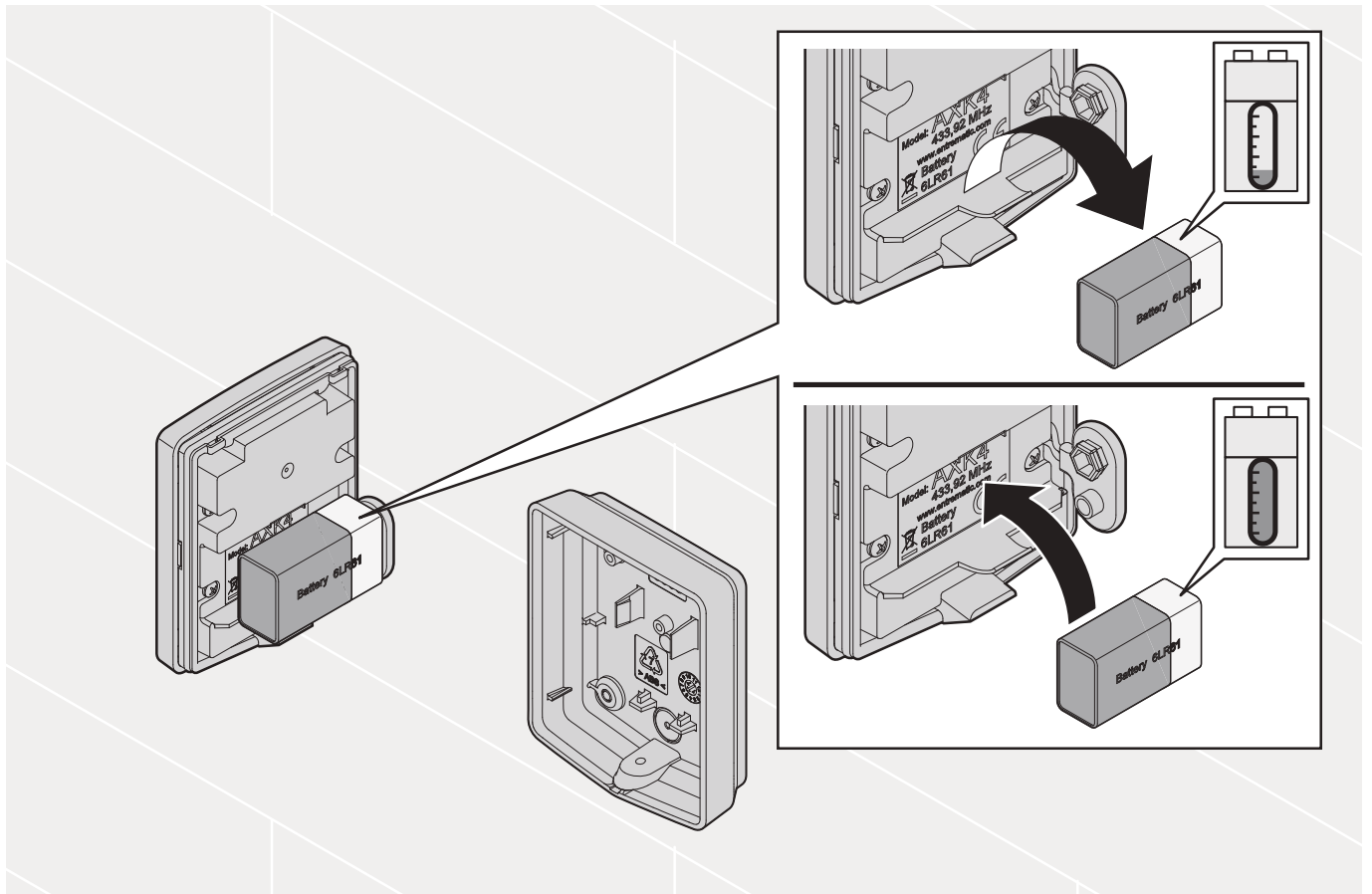

7. Beskrivelse av ikon

7. Kuvakkeiden kuvaus



Fabrikkinnstillinger
Tehdasasetukset



Konfigurasjonskode
Määrittyskoodi



Frigjøring av apparatet
Laitteen lukituksen vapautus



Blokkering av apparatet
Laitteen lukitus



Tidsramme
Ajanjakso



Kode
Koodi



Fast grønt lys
Kiinteä vihreä valo



Intermitterende grønt lys
Vilkkuva vihreä valo



Fast rødt lys
Kiinteä punainen valo



Intermitterende rødt lys
Vilkkuva punainen valo

CH

Kanal (1, 2, 3, 4)
Kanava (1, 2, 3, 4)



En hvilken som helst knapp, unntatt Mikä tahansa painike, lukuun ottamatta



Kun kvalifisert personale
Vain ammattitaitoinen henkilöstö



Feil kode
Virheellinen koodi



8. Fabrikkoder

8. Tehtaan koodit

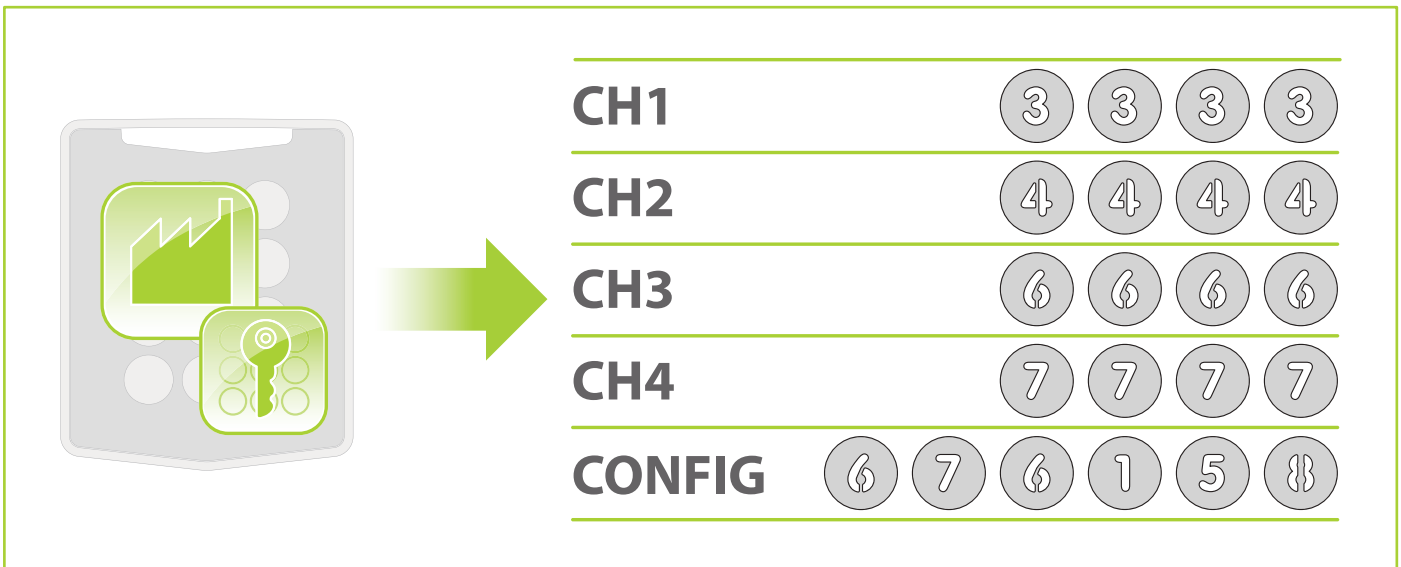

9. Sekvens til grunnleggende kommando

9. Peruskomentojen järjestykset

- Aktiver CHn

- Aktivoi CHn-kanavan

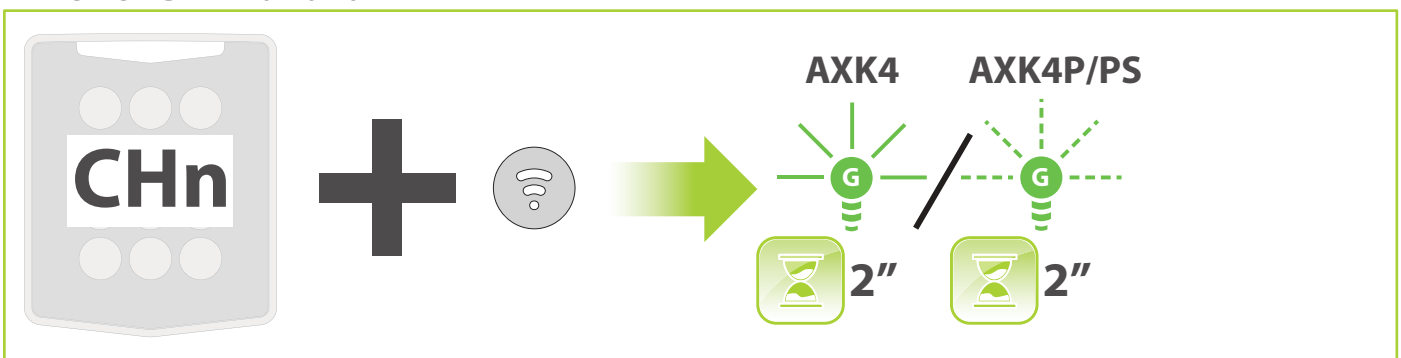

- Aktiver kanalen FRI (dersom den er konfigurert)

- Aktivoi VAPAAN kanavan (jos määritetty)

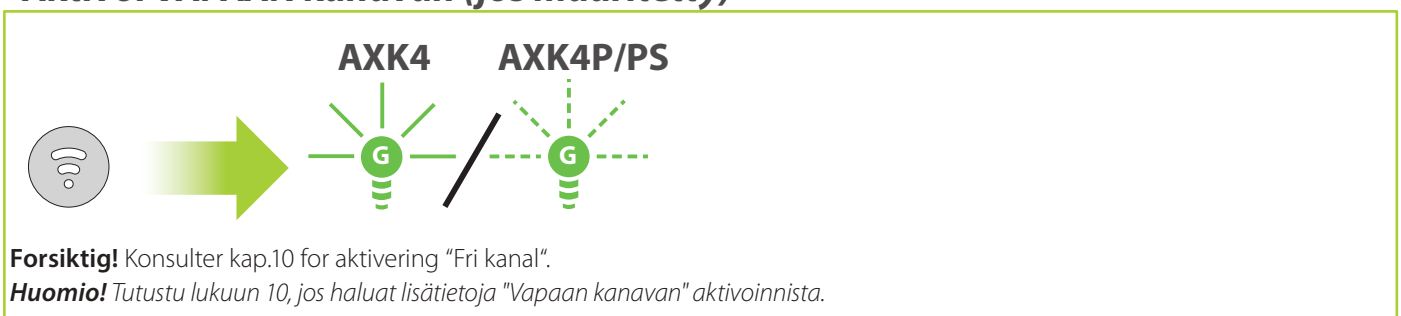

- Gjenta siste kommando (innen 10 s)
- *Toista viimeinen komento (10 sekunnin kuluessa)*

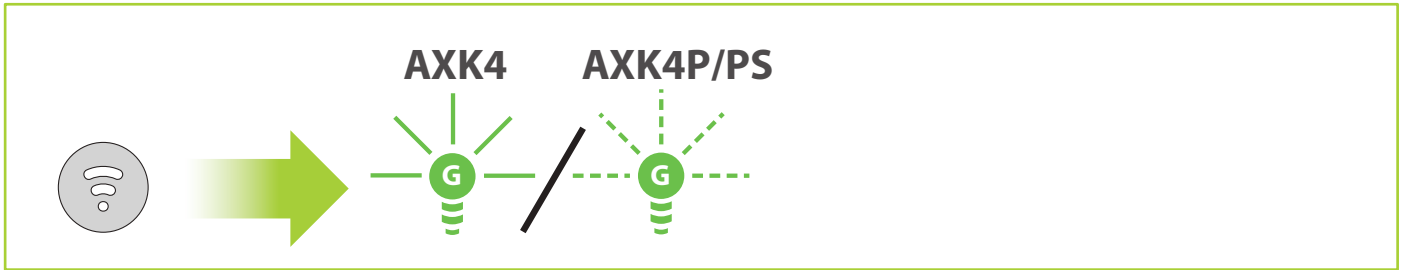

- Aktiver bakgrunnsbelysning
- *Aktivoi taustavalaistus*

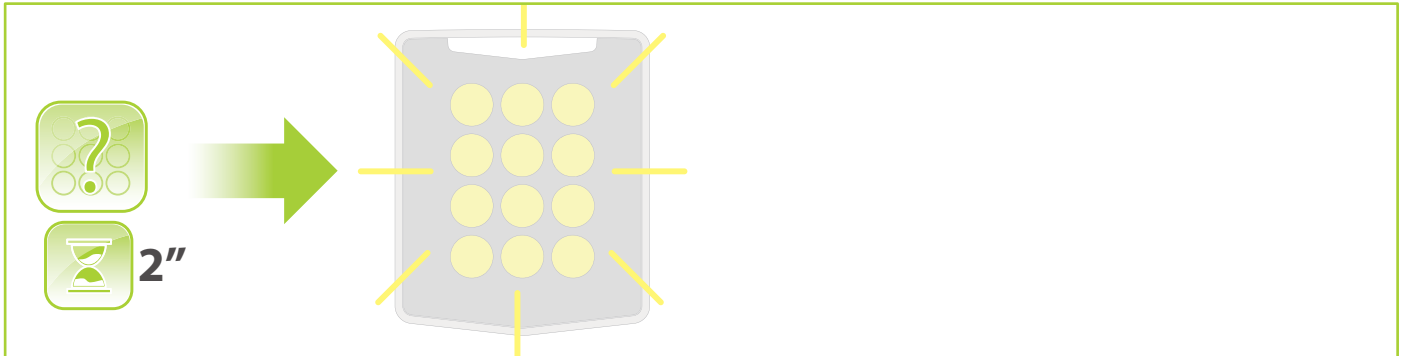

- Slett sekvens som nettopp er tastet inn
- *Peruuta juuri kirjoitettu järjestys*
- Gå ut av modaliteten "Gjenta siste kommando"
- *Käytä tilaa "Toista viimeinen komento"*

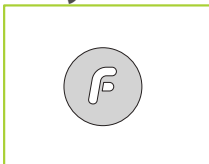

- Identifisering av modell
- *Mallin tunnistus*

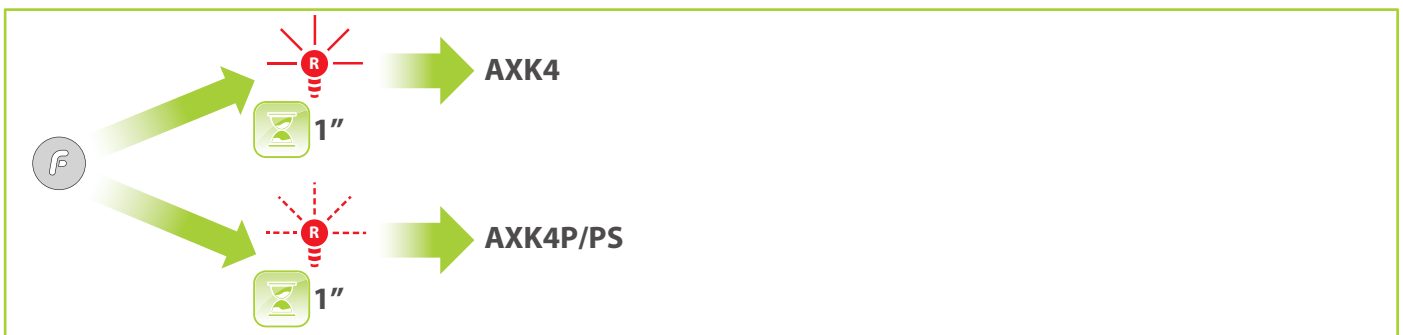

- Feil inntasting av en kode
- *Koodin kirjoitusvirhe*

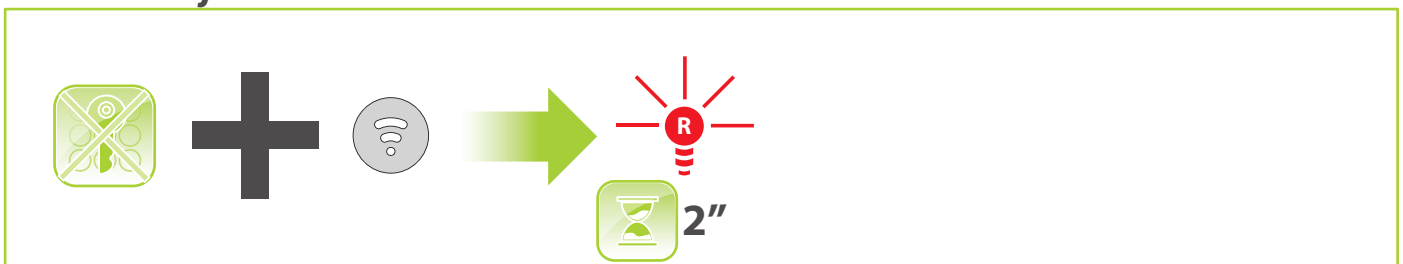

- gjentatt innføring av feil kode
- *Virheellinen koodi syötetty toistuvasti*



- Enhver sekvens med ufullstendige faser vil bli oversett etter 10 s med uten aktivitet, og en vil gå tilbake til en tilstand med stand-by.
- Pausen som oppstår fra det trykkes på en tast og neste må være kortere enn 5 s.
- *Mikä tahansa vajaa näppäinjärjestys jätetään huomiotta 10 sekunnin toimeettoman jakson jälkeen ja palataan valmiutilaan.*
- *Kahden näppäimen painalluksen välisen ajan on oltava alle 5 sekuntia.*

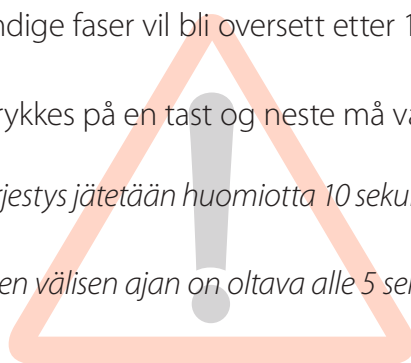

10. Sekvens for skifte av koder

10. Järjestys koodien vaihtoa varten

- Skift gammel kode med en ny
- *Vaihda vanhan koodin tilalle uusi*

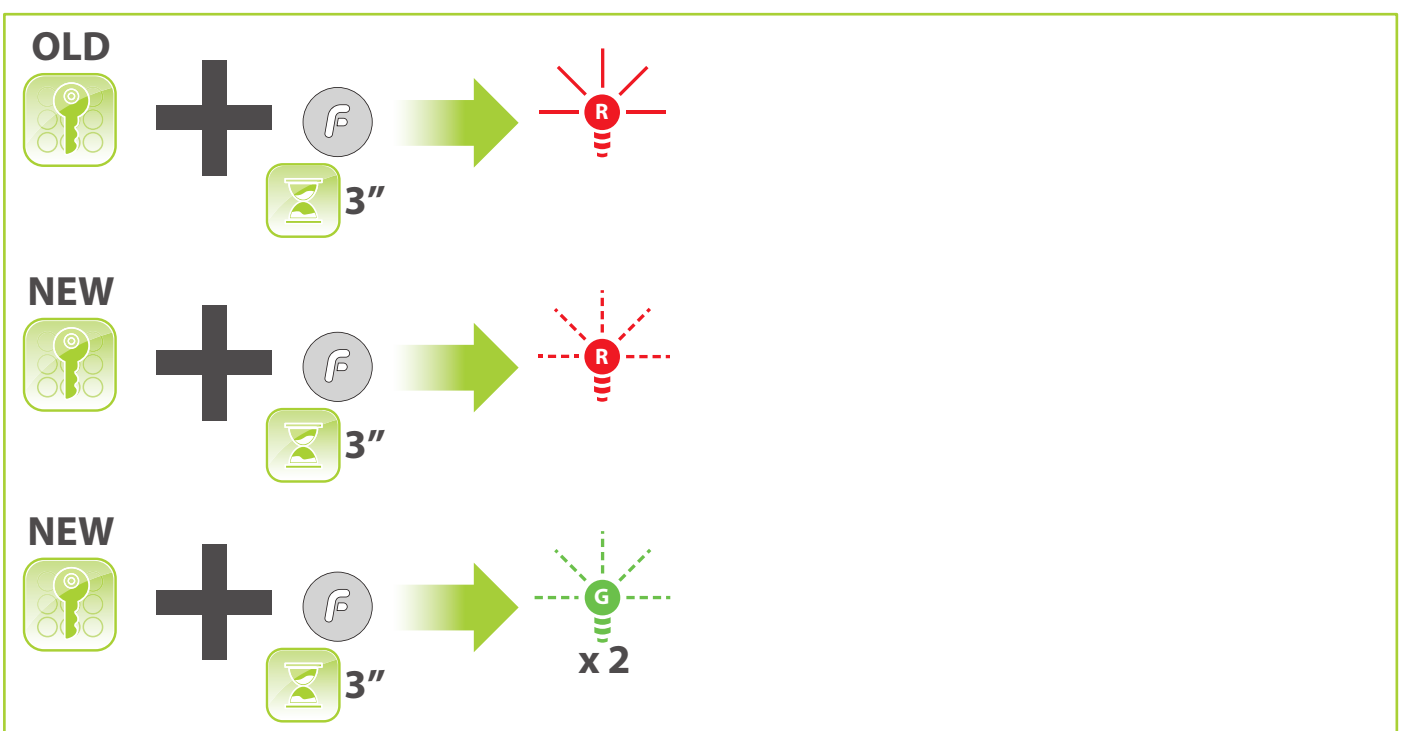

- Konfigurasjon av en kode med "null lengde" (Kanal FRI)
- "Nollan pituisen" koodin määrittäminen (VAPAA kanava)

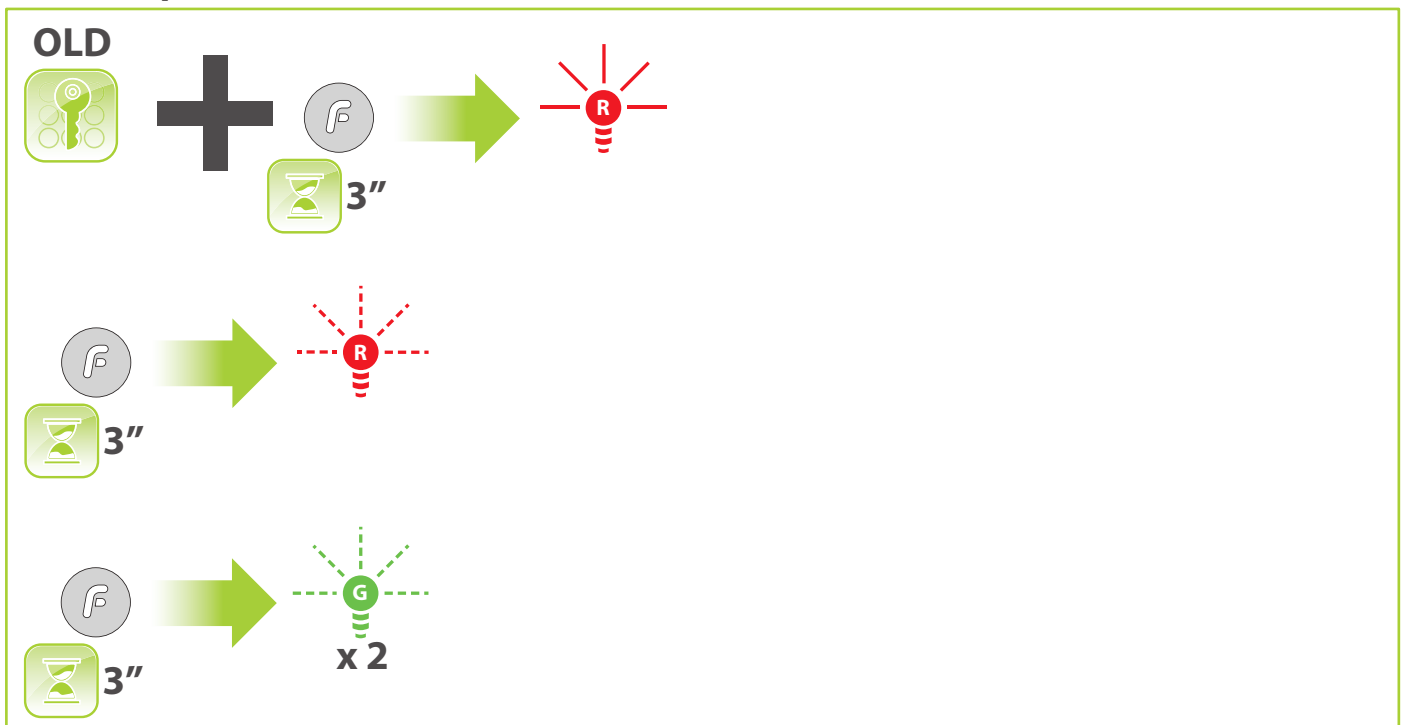

- Brukerkodene må være på en lengde mellom 0 (FRI kanal) og 8 siffer.
- Kun én enkel kanal kan konfigureres som "FRI kanal".
- Derfor kan ikke fabrikkodene brukes til å aktivere andre kanaler enn de som er forhåndsdefinerte (for eksempel kan koden "3333" ikke brukes på ch4).
- En ufullstendig sekvens for å skifte av kode oversees etter 10 s med uten aktivitet, hvor en vil gå tilbake til stand-by.
- En feil sekvens for skifte av kode fører til at den RØDE LED-lampen tennes i 3 s, etter dette går en tilbake til en tilstand med stand-by.

- *Käyttäjän koodien on oltava pituudeltaan välillä 0 (VAPAA kanava) - 8 merkkiä.*
- *Vain yksi kanava voidaan määrittää "VAPAAKSI kanavaksi".*
- *Sen vuoksi tehtaan koodeja ei voi käyttää muiden kuin esimääritettyjen kanavien aktivointiin (esim. koodia "3333" ei voi käyttää CH4:lle).*
- *Koodin vaihdon vajaa järjestys jätetään huomiotta 10 sekunnin toimeettoman jakson jälkeen ja palataan valmiustilaan.*
- *Koodin vaihdon virheellinen järjestys aiheuttaa PUNAISEN MERKKIVALON syttymisen 3 sekunniksi ja tämän jälkeen tuote palaa valmiustilaan.*

11. Tilstand CONFIG

11. MÄÄRIT. tila



- Skifte av gammel CONFIG kode med en ny
- *Vaihda vanha MÄÄRIT. koodi uuteen*

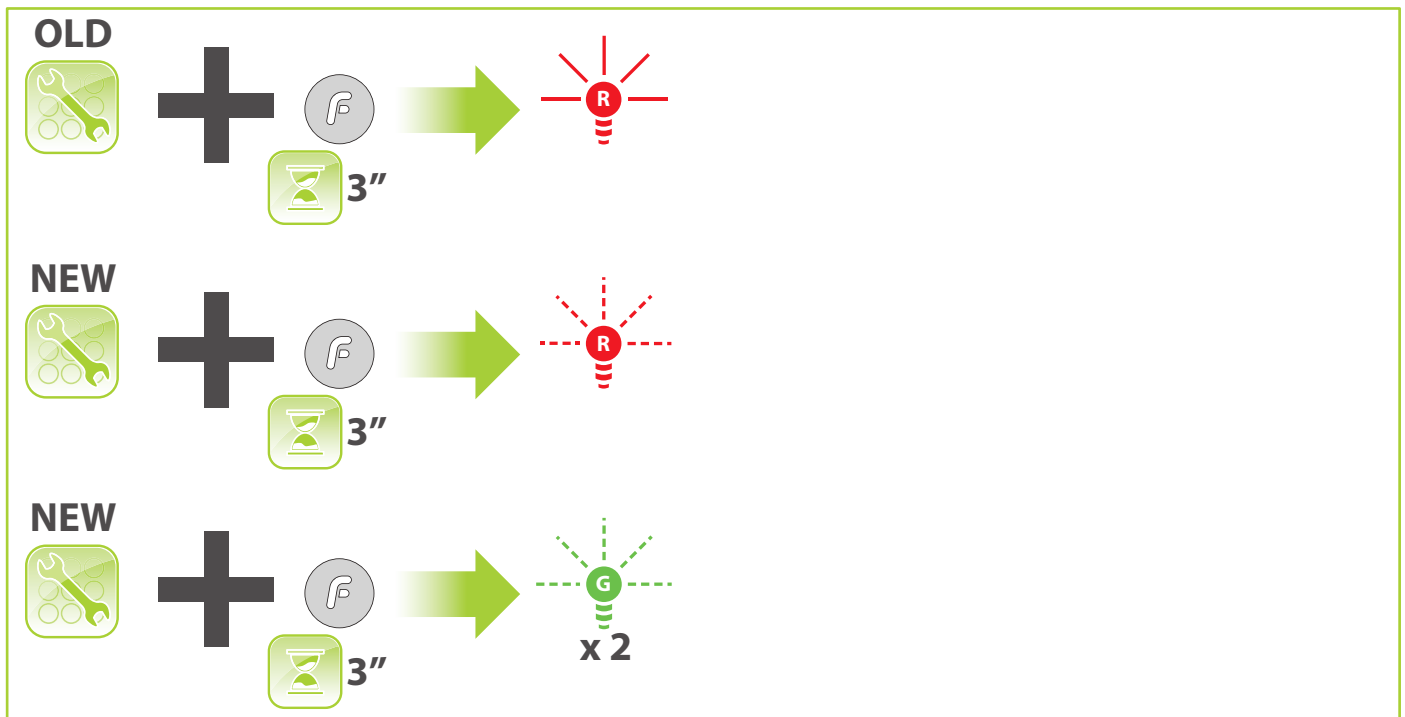

- Tilgang til CONFIG-modaliteten
- *Pääsy MÄÄRIT. tilaan*

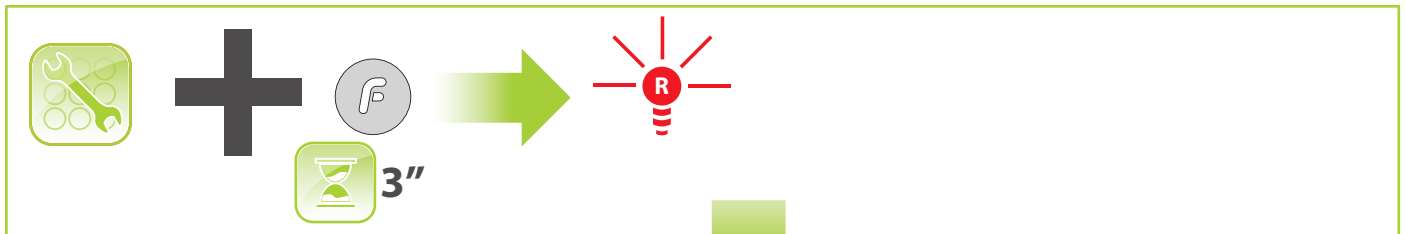

- Gjenopprett FRI kanal som default
- *Palauta VAPAA kanava oletusarvoon*

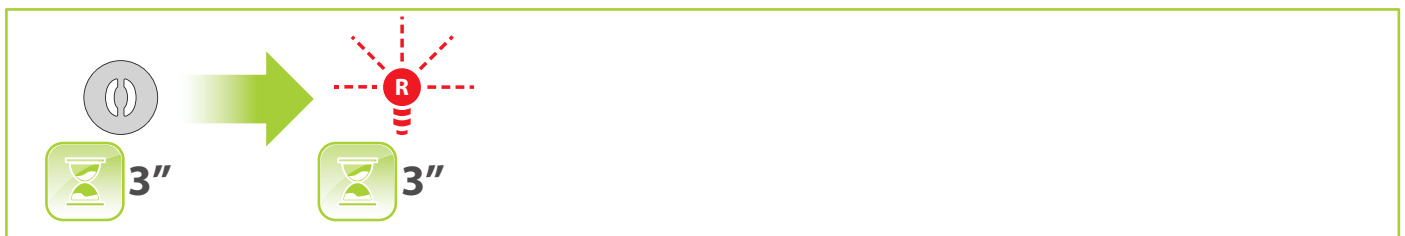

- Skifte ROLL / ENC på CH1-CH2
- *Kytkin ROLL / ENC asennossa CH1-CH2*

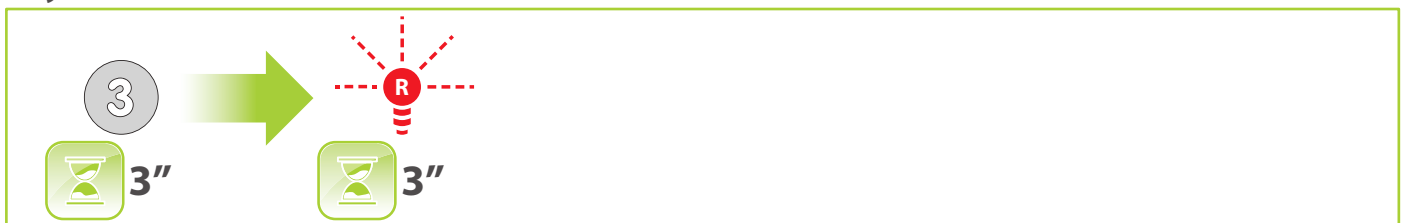



- Skifte ROLL / ENC på CH3-CH4
- Kytkin ROLL / ENC asennossa CH3-CH4

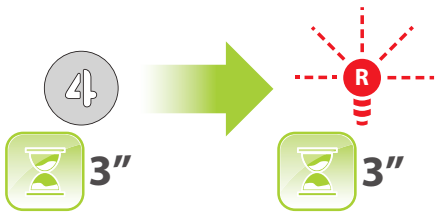

- AKTIVERER funksjon for skifte av koder
- OTA KÄYTTÖÖN koodien vaihtotoiminto

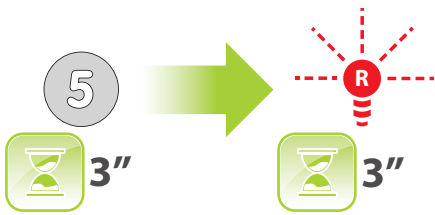

- DEAKTIVERER funksjon for skifte av koder
- POISTA KÄYTTÖSTÄ koodien vaihtotoiminto



- GJENOPPRETT fabrikkkonfigurasjonen
- PALAUTA tehdasmääritykset

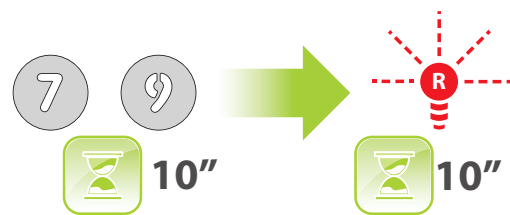

- Total BLOKKERING AV konfigurasjon
- Määritysten täydellinen LUKITUS





- Konfigurasjonskoden (CONFIG) må ha en lengde på mellom 4 og 8 siffer.
- Når en har fått tilgang til konfigurasjonstilstanden, er tiden tilgjengelig for å utføre den ønskede operasjonen lik 30 s. Dersom denne tiden overskrides uten at en har avsluttet operasjonen på gang, vil produktet returnere til stand-by tilstanden uten at det utføres endringer ved produktet.
- Når den totale BLOKKERINGEN av konfigurasjonen aktiveres, vil det ikke lenger være mulig å utføre endringer ved konfigurasjonen eller RESET til fabrikkinnstillingen.
- *Määrittyskoodin (MÄÄRIT) pituuden on oltava välillä 4 - 8 numeroa.*
- *Kun siirytään määrittystilaan, haluttua toimenpidettä varten käytettävissä oleva aika on 30 s. Jos ylitetään kyseinen aika suorittamatta loppuun käynnissä olevaa toimenpidettä, tuote palaa valmiustilaan suorittamatta mitään muutoksia tuotteeseen.*
- *Kun aktivoidaan määrittysten täydellinen LUKITUS, ei ole mahdollista suorittaa mitään muutoksia määrittelyihin tai tehdasarvojen RESETOINTIIN.*



Entromatic Group AB
Lodjursgatan 10
SE-261 44, Landskrona
Sweden
www.entromatic.com

